



OWNER'S MANUAL

CONTENTS

Important Safety Instructions	2	Start-Up Procedures	14
Spa System Components	4	Operating Instructions	15
Spa Installation	5	Jet and Therapy Control	18
Electrical Information	6	Maintenance	19
120 Volt or 240 Volt Installation	8	Problem Solving Guide	21
Equipment Control Panel	10	Limited Warranty Summary	24
Filtration Time Clock	12	Spa Soaking Guidelines	24
Heating Time Clock	13		

OWNER'S RECORD

Date Purchased _____

Purchased From _____

Installed By _____

Serial Number _____ Model _____

SAVE THIS INFORMATION FOR FUTURE USE



IMPORTANT SAFETY INSTRUCTIONS

**CAUTION: RISK OF ELECTRICAL SHOCK.
READ AND FOLLOW ALL INSTRUCTIONS
SAVE THESE INSTRUCTIONS**

1. Take special care to make sure your spa has a level, solid foundation. You must install your spa to provide drainage away from the electrical component compartment.
2. The very young, or aged, those with illness, heart conditions or under doctor's care should not use the spa unattended. Infants should not be permitted in the spa at water temperatures over 100°F.
3. To reduce the risk of injury:
 - A. The water in a spa or hot tub should never exceed 40°C (104°F). Water temperatures between 38°C (100°F) and 40°C (104°F) are considered safe for a healthy adult. Lower water temperatures are recommended for extended use (exceeding 10-15 minutes) and for young children.
 - B. Since excessive water temperatures have a high potential for causing fetal damage during the early months of pregnancy, pregnant or possibly pregnant women should limit spa or hot tub water temperatures to 38°C (100°F).
 - C. Before entering a spa or hot tub, the user should measure the water temperature with an accurate thermometer since the tolerance of water temperature-regulating devices may vary as much as ±3°C (5°F).
 - D. The use of alcohol, drugs, or medication before or during spa or hot tub use may lead to unconsciousness with the possibility of drowning.
 - E. Persons suffering from obesity or with a medical history of heart disease, low or high blood pressure, circulatory system problems, or diabetes should consult a physician before using a spa or hot tub.
 - F. Persons using medication should consult a physician before using a spa or hot tub since some medication may induce drowsiness while other medication may affect heart rate, blood pressure, and circulation.
4. **DANGER:** To reduce the risk of injury, do not permit children to use this product unless they are closely supervised at all times.
5. Special care should be taken when using the spa and consuming alcoholic beverages. Alcohol, drugs, and some medications affect a person's ability to withstand the high temperatures and could produce dangerous effects.
6. Do not use electrical appliances such as television, radio, lights, cooking devices, or telephones within 10 feet of the spa while the spa is being used. Lighting fixtures must not be located directly above or within 10 feet of the spa. Lighting fixtures located within 20 feet of the spa must be on a circuit protected by a GFCI.
7. Do not use an extension cord to power your spa. This may cause an electric shock or may permanently damage your portable spa and may void the warranty.
8. Do not plug in the spa unless it is filled with water to the normal water level 6" below the top of the spa lip. Starting the spa when the water level is low can damage the circulation pump and heater and could cause a fire.
9. Keep your water chemistry correctly balanced. Untreated spa water will cause problems with your spa and support equipment. Maintaining the correct balance is simple if you just take time to read your test kit instructions and check your water regularly. (Damage to your spa or equipment due to improper water balance will not be covered by warranty.)
10. Clean your filter about once a month if you use the spa frequently. Do not allow people in your spa with suntan lotion or other oils on their skin. It will coat and inhibit efficient filter operation.
11. Do not allow hair and clothing within twelve inches (12") of skimmers, suction fittings or drains at any time. Persons with long hair should either secure hair to a minimum length or wear a bath cap. **DANGER** — To reduce risk of injury, do not remove suction grate or cover.
12. The wet surface of the spa is slippery. Enter and exit the spa slowly and cautiously.



13. After use, immediately replace your cover. Using a spa cover will save utility costs, keep your spa cleaner and provide added safety when the spa is left unattended. Moreover, since the spa stays warmer, it heats up faster and is more convenient to use. Note: Spa cover is not capable of supporting weight of people. Do not allow anyone to stand on the cover.
14. Be sure to align the equipment cabinet door and secure with the door latch. It is necessary to have the equipment panel door properly in place to operate the spa.
15. Do not lift the spa from the top edge of the equipment panel door housing. This could damage the spa cabinet. Always lift the spa from the bottom!
16. (Cord-connected units) Connect power cord only to a properly grounded, dedicated receptacle.
17. Check GFCI for proper operation prior to use. This appliance is provided with a ground fault circuit interrupter located on the face of the control box. Before each use open door, push the test button. The reset button should appear. Push the reset button. Close the door. The unit should now operate normally. If the interrupter does not perform in this manner, a ground current is flowing indicating the possibility of an electric shock. Disconnect the power until the fault has been identified and corrected.
18. **MAKE SURE YOU HAVE A LICENSED ELECTRICIAN MAKE THE FINAL ELECTRICAL CONNECTIONS.**
19. (Cord-connected units) Do not bury power cord.
20. **WARNING** - To reduce the risk of electrical shock, replace damaged cord immediately.
21. **DANGER - RISK OF ELECTRIC SHOCK.** Install at least 5 feet (1.5 meters) from all metal surfaces. (A spa may be installed within 5 feet of metal surfaces if each metal surface is permanently connected by a minimum No. 8 AWG (8.4 mm²) solid copper conductor attached to the wire connector on the terminal box that is provided for this purpose.)

IMPORTANT SAFETY INSTRUCTIONS

**CAUTION: RISK OF ELECTRICAL SHOCK.
READ AND FOLLOW ALL INSTRUCTIONS**

SAVE THESE INSTRUCTIONS

1. **WARNING - RISK OF CHILD DROWNING**
Extreme caution must be exercised to prevent unauthorized access by children. To avoid accidents, ensure that children cannot use a spa or hot tub unless they are supervised at all times.
2. The electrical supply for this product must include a suitably rated switch or circuit breaker to open all ungrounded supply conductors to comply with Section 422-20 of the National Electrical Code, ANSI/NFPA 70-1987. This disconnecting means must be readily accessible for operation but installed at least 5 feet (1.5 meters) from the spa tub water.
3. A pressure wire connector is attached to the control box inside this spa to permit connection of a minimum No. 8 AWG (8.4 mm²) solid copper ground bonding conductor between this point and any metal equipment, metal electrical boxes or fixtures, metal water pipes or conduits that are within 5 feet (1.5 meters) of the spa as required to comply with local code requirements.

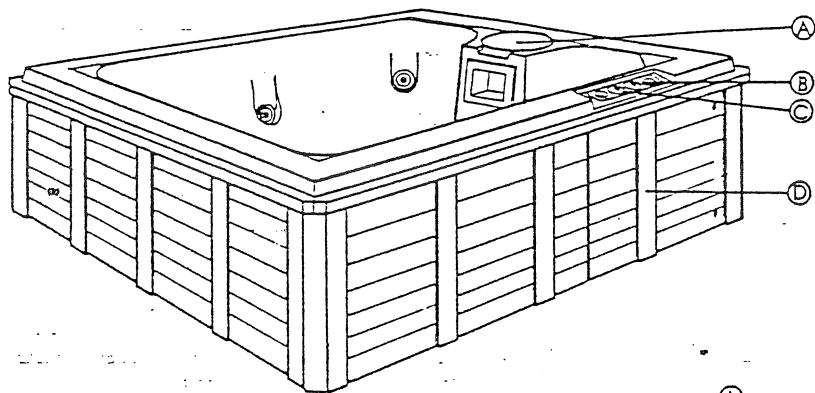
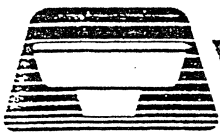

100 Series

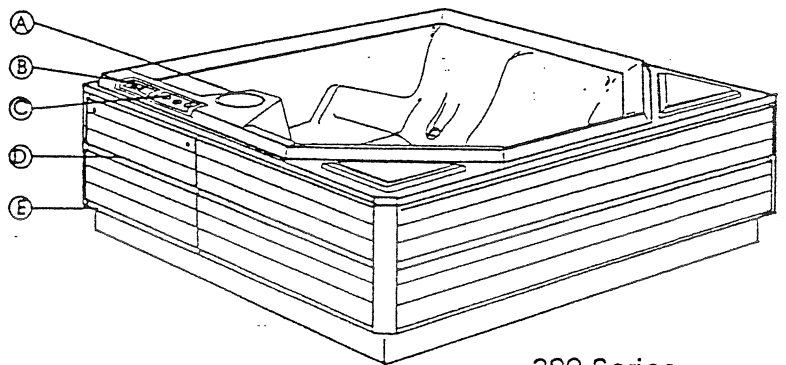

300 Series

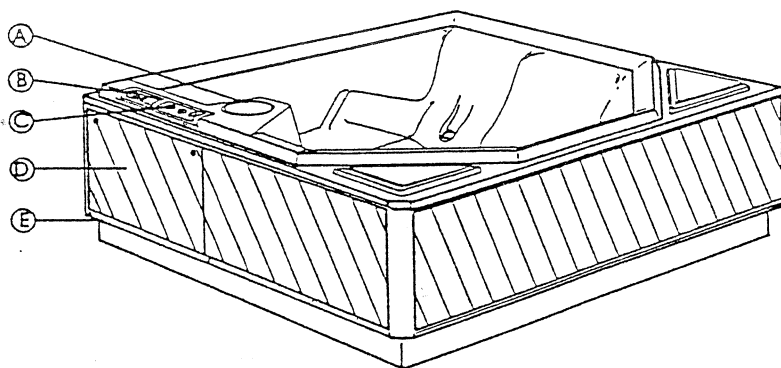

200 Series

SPA SYSTEM COMPONENTS

- A. FILTER SKIMMER/WEIR DOOR - Removes floating debris from the water surface, provides a water return path to equipment, and houses water filter element.
- B. SPA SIDE CONTROL PANEL - Used to control temperature setting, pump for hydro jets, air blower for massaging bubble action, and light.
- C. AIR MIXTURE CONTROLS - Increases or decreases air entering the hydro-massage jets (should be closed when heating.) If using an ozonator, check manufacturers instructions.
- D. EQUIPMENT PAK - Spa support system consisting of 2-speed pump, water heater, air blower, filter, and associated electrical controls (not shown).
- E. PEDESTAL MOOD LIGHTING (300 Series Only) - Adds beauty and safety to your spa area. It will illuminate approximately 3' around the cabinet.

SPA INSTALLATION

BE SURE TO READ THE FOLLOWING INFORMATION BEFORE CONNECTING YOUR SPA TO AN ELECTRICAL SOURCE!

DANGER: RISK OF ELECTRICAL SHOCK. INSTALL AT LEAST 5 FEET FROM ALL METAL SURFACES.

(For all permanently connected units not provided with an integral disconnecting means.) The electrical supply for this product must include a suitably rated switch or circuit breaker to open all ungrounded supply conductors to comply with Section 422-20 of the National Electrical Code, ANSI/NFPA70-1987. The disconnecting means must be readily accessible but installed at least 5 feet (1.5 meters) from tub water.

OUTDOOR INSTALLATION

Keep the following factors in mind when installing your spa outdoors.*

1. Local codes pertaining to fencing.
2. Local electrical and plumbing codes.
3. View from your house.
4. Wind direction.
5. Exposure to sunlight.
6. Location in regard to trees (falling leaves and shade problems).
7. Dressing and bathroom location.
8. Storage area for maintenance equipment and chemicals.
9. Location to facilitate adult supervision.
10. Landscaping and nighttime lighting.
11. Easy access to Equipment Pak door.
12. Power cord location and foot traffic.

*If your spa is installed outdoors, we recommend that you provide a concrete pad for the spa to rest on (8 x 8 x 4" thick level pad).

INDOOR INSTALLATION

1. Indoor spas promote high humidity, so a means of decreasing this humidity must be provided. This can be accomplished by using either ventilation fans or oversized dehumidifiers. Consult your dealer.
2. Floor drains should be provided to drain off water splashed from the spa which may cause walking hazards and/or water damage.
3. Floor area should be flat and non-skid.
4. Walls, ceilings, woodwork should be of materials capable of withstanding high humidity (redwood, cedar).
5. Be sure floor load bearing capacities are adequate to support the concentrated spa weight.
6. Spas should be double checked for leaks before taking inside to avoid possible water damage.
7. Indoor sunrooms are capable of maintaining high ambient temperatures which may effect the spa water temperature. It is not recommended that you operate your pump on the continuous/24 hr. cycle under these conditions.

GENERAL

Locate the spa on solid, level ground, foundation or flooring. Keep in mind the weight of the filled spa (in excess of 4,000 lbs. on some models). If you have any doubts about the load bearing ability of your chosen site, contact an architect, your building department or other knowledgeable authority. It is important that the entire perimeter of the spa cabinet and the spa bottom are evenly supported.

Should you install your portable spa below floor level you must provide room to allow access for servicing from above or below the floor. Your spa must be installed to provide drainage for the electrical compartment.

Because of equipment accessibility and drainage problems, the manufacturer recommends that you do not install below floor level.

NOTE: Access must be left for maintenance on the complete equipment side (both equipment door panels and side fixed panel).

NOTE: Plumbing of any ozone unit is the responsibility of the dealer.



ELECTRICAL INFORMATION

**CAUTION: RISK OF ELECTRICAL SHOCK.
READ AND FOLLOW ALL INSTRUCTIONS**

IMPORTANT SAFETY INSTRUCTIONS

Prior to performing any service to the spa package turn OFF ALL primary electric power at the main circuit breaker or disconnect panel.

All field electrical connections can be made by removing the front panel of the electrical control box on the 200 and 300 series or the top cover on the 100 series.

All electrical connections to this spa package must be accomplished by a qualified electrician in accordance with the National Electric Code or the Canadian Electric Code and in accordance with any local electrical codes in effect at the time of installation.

All connections should be made in accordance with the wiring tag enclosed in the electrical control box or the wiring diagrams within this manual.

This equipment is designed to operate on 60Hz Alternating Current only, at a voltage of 120 or 240 volts as required.

Connections should be made using copper conductors only. The connecting wire and circuit breakers or fuses must all be sized to accommodate the Total Ampere load as specified on the equipment module data label.

(Cord-connected units) Connect power cord only to a properly grounded dedicated receptacle.

(Cord-connected units) A pressure wire connector is provided on the surface of the control box inside the spa to permit connection of a bonding wire between this point and any metal equipment, metal enclosures of electrical equipment, metal water pipe or conduit within five feet of the unit as needed to comply with local requirements. The bonding wire must be at least a No. 8 AWG solid copper wire.

(Permanently-connected units) A green colored terminal (or a wire connector marked "G," "GR," "Ground," or "Grounding") is provided in the control box. To reduce the risk of electric shock, connect this terminal or connector to the grounding terminal of your electric service or supply panel with a continuous green insulated copper wire equivalent to the circuit conductor supplying this equipment, but no smaller than No. 12 AWG. In addition, a second wire connector is provided for bonding to local ground points. To reduce the risk of electric shock, this connector should be bonded with a No. 8 AWG copper wire to any metal ladders, water pipes, or any metal within 5 feet of the tub.

(Permanently-connected units) A hole can be drilled in the pedestal or base of the unit to bring the conduit to the hole provided in the equipment compartment. All equipment is provided with a ground fault circuit interrupter on the equipment panel. Before each use open door, push test button. The reset button should appear. Push the reset button. Close the door. The unit should now operate normally. If the interrupter fails to operate in this manner, there is a ground current flowing, indicating the possibility of an electrical shock. Disconnect the power until the source of the breakdown has been identified and corrected.

120 VOLT INSTALLATION CONNECT TO GROUNDED TYPE RECEPTACLE ONLY CORD CONNECTED

Electrical Requirements (Model 80, 100 series and 200 series models): 120 Volts, 60Hz, Single Phase, 20amp., grounded receptacle.

Models 80, 180, 120 and 155 are wired for 120 volt, cord-connected operation from the factory. All other models must have all electrical connection made by a qualified licensed electrician, in accordance with the national electrical code. Other appliances or electrical equipment cannot be used on this circuit.

Be sure to isolate the power cord from all foot traffic areas to prevent cord damage or tripping accidents. Route the cord through the hole in the side of the cabinet provided for this purpose.

PERMANENTLY CONNECTED

Electrical Requirements (300 series models): 120 Volts, 60Hz, Single Phase, 30 amp., grounded receptacle.

Equipment modules wired for 120 volt operation require a 3 wire electrical service (line 1, black), (neutral, white) and (ground, green). Refer to terminal block diagram on page 8.

240 VOLT INSTALLATION

Electrical Requirement: 240 Volts, 60Hz, Single-Phase, 50 amp., 4 wire service.

Units to be operated at 240 volts must have all electrical connections made by a qualified electrician in accordance with the National Electric Code, the Canadian Electrical Code or other local electrical codes in effect at the time of installation.

DO NOT RUN CONDUIT THRU THE VENT HOLES BELOW THE DOOR.

Equipment modules installed for 240 volt operation require a 4 wire, 50 amp., 240 volt subfeed in non-metallic pipe to the spa equipment compartment (line 1, line 2, neutral and ground). Refer to terminal block diagram on page 6. Take precautionary steps to ensure that all procedures regarding the conversion information have been implemented. See page 8.



120 VOLT OR 240 VOLT INSTALLATION (PERMANENTLY CONNECTED UNITS)

All electrical connections to the Equipment Module must be accomplished by a qualified electrician in accordance with the National Electrical Code or the Canadian Electric Code and in accordance with any local electrical codes in effect at the time of installation.

120 VOLT WIRING DIAGRAM

To wire the Equipment Module for 120 volt operation, follow the wiring diagram below and, if equipped, install the brown conversion plug as shown below.

Equipment Modules installed for 120 volt operation require a two-wire electrical service, plus ground (line 1, neutral, and ground).

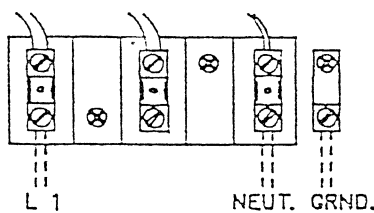

TO REMOVE BROWN PLUG:
SQUEEZE LOCKS
ON ENDS OF PLUG
& PULL STRAIGHT OUT.

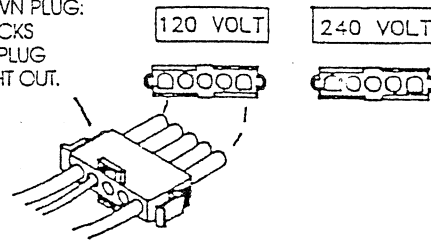

MOVE THE BROWN PLUG,
LOCATED ABOVE THE TERMINAL
BLOCK, TO THE 120 VOLT
POSITION (LEFT).

FIELD SUPPLIED WIRING
USE COPPER CONDUCTORS

240 VOLT WIRING DIAGRAM

To wire the Equipment Module for 240 volt operation, follow the wiring diagram below and, if equipped, install the brown conversion plug as shown below.

Equipment Modules installed for 240 volt operation require a three-wire electrical service, plus ground (line 1, line 2, neutral, and ground).

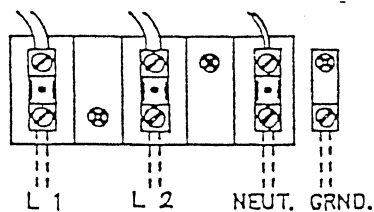

TO REMOVE BROWN PLUG:
SQUEEZE LOCKS
ON ENDS OF PLUG
& PULL STRAIGHT OUT.

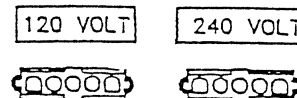

MOVE THE BROWN PLUG,
LOCATED ABOVE THE TERMINAL
BLOCK, TO THE 240 VOLT
POSITION (RIGHT).

FIELD SUPPLIED WIRING
USE COPPER CONDUCTORS

EQUIPMENT SYSTEM

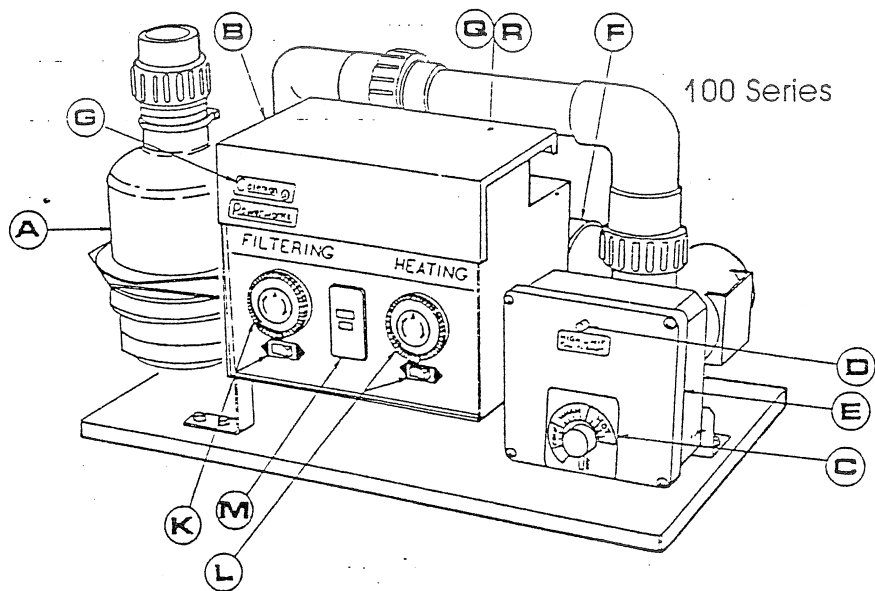
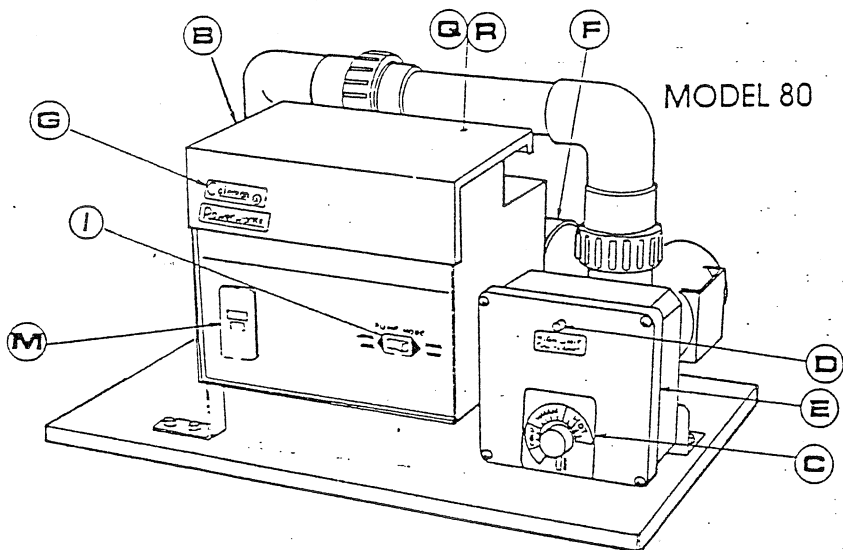

- A. BLOWER
- B. ELECTRICAL CONTROL BOX
- C. THERMOSTAT (Model 80 and 100 series only)
- D. HIGH LIMIT SWITCH
- E. HEATER ASSEMBLY
- F. PUMP
- G. MANUFACTURERS I.D.
- H. SLICE VALVE - PUMP HEATER (200/300 only)
- I. PUMP MODE SWITCH
- J. MAIN POWER SWITCH (200/300 only)
- K. FILTERING TIME CLOCK/SWITCH (100/200/300)
- L. HEATING TIME CLOCK/SWITCH (100/200/300)
- M. G. F. C. I.
- N. DOOR INTERLOCK
- O. THERAPY SELECTOR VALVE (200/300 only)
- P. TEMPERATURE SENSOR TUBE (200/300 only)
- Q. AIR SENSOR CONNECTIONS
- R. ELECTRIC CONNECTIONS
- S. DRAIN

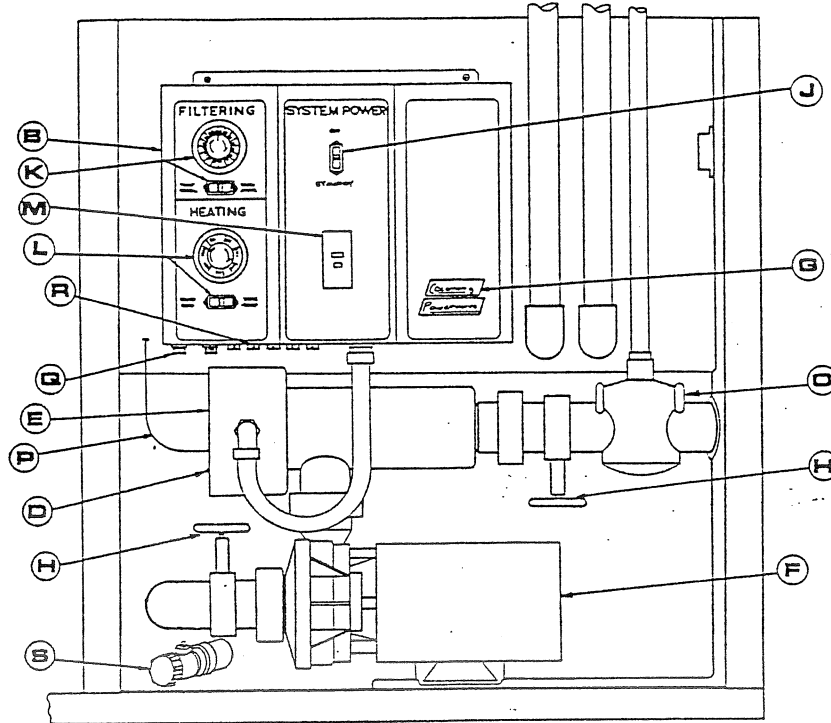

EQUIPMENT CONTROL PANEL

- A. AIR BLOWER - Provides a large volume of air to the air holes in the floor and/or seat of the spa for a vigorous bubble action (located behind or inside compartment).

NOTE: BLOWER TEMPERATURE - The temperature of the air from the blower is directly related to the ambient air temperature. Depending on the temperature, you may find that air from the blower feels either hot or cold. We recommend that you consider this and use the blower accordingly. Below is a chart which outlines the average comfort zone considering ambient air temperature.

	AMBIENT OUTDOOR TEMPERATURE	AIR CHANNEL TEMPERATURE	PERCEIVED SENSATION
	40°	70 - 80	COOL
COMFORT ZONE	60	90 - 100	LUKE WARM
	70	100 - 110	WARM
	80	110 - 110	WARMER
	90	120 - 130	VERY WARM
	100	130 - 140	HOT

COMFORT ZONE - IDEAL AMBIENT AIR TEMPERATURE FOR OPERATING AIR BLOWERS

1) Temperatures BELOW this comfort range will cause the water to cool off rapidly. This wastes electricity, as the spa water will have to be reheated.

2) Temperatures ABOVE this comfort range can cause some discomfort due to your skin sensing the differential between the water and air temperatures. Some people are more sensitive than others and will feel discomfort at lower temperatures. The blower can be turned to low speed or off to avoid discomfort.

3) Very warm and hot temperatures may be perceived after about 10 minutes of air blower operation.

- B. ELECTRICAL CONTROL BOX - Contains the remote control mechanism and provides a central connection point for all electrical components.
- C. THERMOSTAT - Controls water temperature between 50° and 104°.
- D. HIGH LIMIT SWITCH - The electric heater is equipped with a High-Limit safety switch that will shut the heater OFF if the temperature within the heater assembly reaches a factory-set, high temperature limit.

Several conditions could cause the high-limit switch to turn the heater OFF:

1. Water level in spa too low,
2. Valves in plumbing closed while Heater is on,
3. Dirty filter, impeding water flow,
4. Plumbing lines plugged, restricting water flow,
5. Defective or inoperative pump,
6. Faulty heater thermostat,
7. Unusually high temperature under spa skirt.

The high limit switch cannot be re-set until the temperature within the heater assembly drops several degrees. Should the high-limit switch trip repeatedly, the Equipment Module should not be operated until the problem has been corrected. Contact your local dealer to remedy this problem.

- E. HEATER ASSEMBLY - Thermostatically controlled and equipped with a high-limit safety shut-off. Models 80 and 100 series spas have a thermostat control mounted on the heater assembly.
- F. TWO SPEED PUMP - Low speed for efficient water circulation during filtration and heating; High speed for maximum action of the hydro jets. The pump functions are activated by topside controls.
- G. MANUFACTURER'S IDENTIFICATION LABEL - contains important identification information for warranty service.
- H. SLICE VALVE - (Service) Used to shut off water flow from the spa to the equipment pak while servicing. It should be open during normal operations.
- I. PUMP MODE SWITCH - (model 80 only) -
Continuous 24 hour Operation - In this position the switch allows the pump to run continuously in the low speed, circulation filtration mode while the heater will cycle on and off as determined by the setting of the thermostat. This position provides maximum filtration of the spa water and permits maintaining an even, constant water temperature.
Thermostat Controlled - In this position the pump low speed operation will be controlled by the thermostat; the pump low speed and the heater will start and stop together.
- J. MAIN POWER SWITCH - Used to turn on all of the electrical components of the equipment module.
- K. FILTER TIME CLOCK - See page 12.
- L. HEATING TIME CLOCK - See page 13.
- M. G. F. C. I. - See page 5.
- O. THERAPY SELECTOR VALVE - (200 & 300 series spas) See page 18.
- P. TEMPERATURE SENSOR TUBE
DO NOT KINK OR BEND
- Q. AIR SENSORS CONNECTIONS - Clear tube connections for the function and light switches.

- R. ELECTRICAL CONNECTIONS - The electrical plugs for the unit connect here. All existing connections should be intact. Note: these are under the cover on series 80 & 100 equipment packs.
- S. DRAIN - Connection for hose to drain spa.

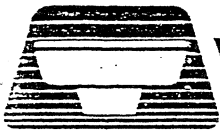

FILTRATION TIME CLOCK

The filtration time clock built into the equipment control console provides the ultimate in operating convenience and economy. The spa water can be filtered daily or several times each day to maintain a sparkling clear, clean condition with ideal chemical distribution. The water temperature can be automatically controlled to be ready to use whenever desired, either day or night. The two time clocks operate independently of each other and may be overridden at any time while using spa on the high speed modes. Filtration times vary depending on use, however a good recommended starting point is 4 hours per day.

FILTRATION TIME CLOCK-24 HOUR OPERATION (on all 100, 200 and 300 series models)

- A. Clock Set Point - Rotate outer clock ring clockwise and set correct time of day opposite Set Point Arrow.
- For an initial setting, try two 60-minute ON settings spaced evenly around the clock. Wait a few days and adjust as necessary to maintain sparkling clear water with the minimum of ON times.
- B. Time Clock Lugs - Push inward toward center of clock to set ON times. Each lug represents a 15 minute time period. Any combination of cycles is possible. The example shows ON at 11:00 AM and OFF at 1:30 PM. To cancel settings push outward on the lugs.

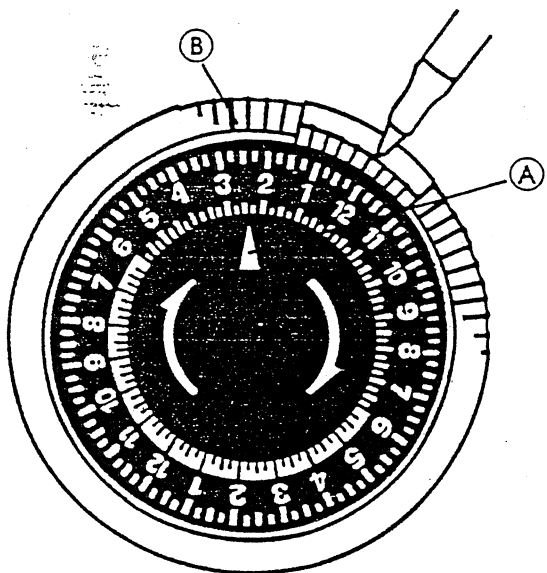

FILTRING BY-PASS SWITCH

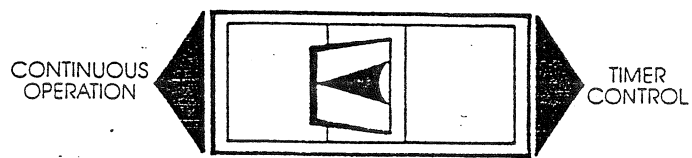

In this position, the filtration cycle will run continuously. Use this when extra filtration is desired following periods of heavy spa usage or when adding chemicals and during extreme cold weather (below 40 degrees) to inhibit system freeze up. The time clock settings are not disturbed and timed cycles will begin again when this switch is returned to the **TIMER CONTROL** position.

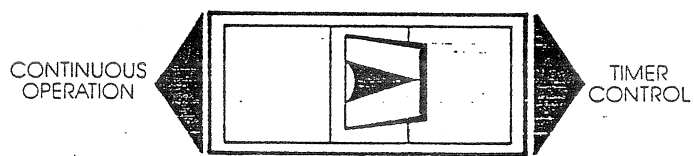

In this position the time clock has control and will start and stop the filtration cycle as determined by the settings of the **FILTRING** time clock lugs.

HEATING TIME CLOCK

HEATING TIME CLOCK: 7 DAY OPERATION (On all 100, 200, and 300 series models)

- A. Clock set point - Rotate outer clock ring clockwise and set correct time of day opposite Set Point Arrow.

If the thermostat is calling for heat and the time clock reaches an ON time, the pump will start and the heater will turn ON. When the water reaches the desired temperature the thermostat will turn the heater and the pump OFF. This cycle will continue during each ON period as determined by the setting of the time clock lugs. The HEATING time clock should be set for heating during your normal hours and days of usage.

- B. Time Clock lugs - Push inward toward center of clock to set ON time. Each lug represents a 2 hour period of a selected day of the week. The example shows ON at 6:00 AM Friday and OFF at Midnight Friday. To cancel settings push outward on the lugs.

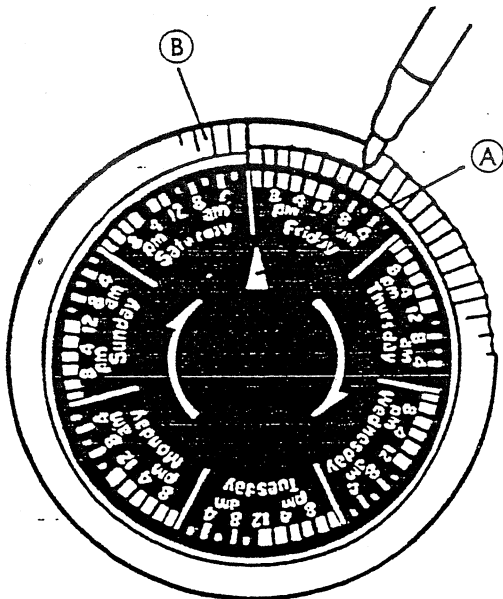

HEATER BY-PASS SWITCH (On all 100, 200, and 300 series models)

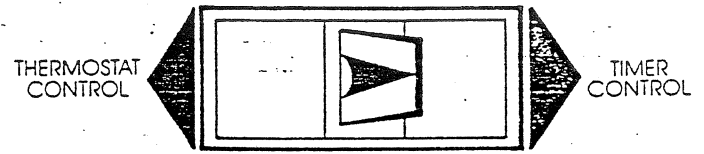

In this position the time clock has control and will start and stop the heating cycle as determined by the settings of the HEATING time clock lugs. The maximum water temperature is controlled by the thermostat setting.

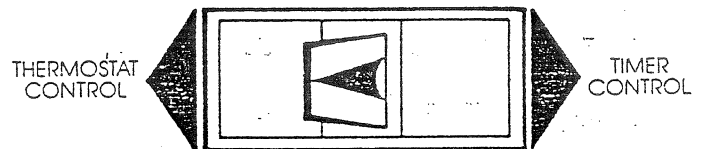

In this position the heating cycle will be continuous, controlled only by the setting of the thermostat. The heater will start and stop as required to maintain the desired temperature. This position is ideal for freeze protection. With the thermostat set at the FREEZE position, the heater will automatically cycle to maintain a water temperature of approximately 50 degrees. The time clock settings are not disturbed and timed cycles will begin again when this switch is returned to the TIMER CONTROL position.

NOTE: DURING EXTREMELY COLD WEATHER CONDITIONS, WHEN POWER FAILURES ARE POSSIBLE, THE SPA WATER TEMPERATURE MUST BE MAINTAINED AT BETWEEN 90 AND 100 DEGREES. SHOULD A POWER FAILURE OCCUR, IT WILL TAKE A DAY OR MORE FOR THE SPA WATER TO DROP TO A FREEZING TEMPERATURE, THUS PROVIDING GREATER PROTECTION AGAINST FREEZE UP.

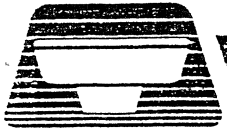

START — UP PROCEDURES

First, follow recommendations for site location and electrical connection. **DO NOT PLUG IN UNIT** at this time. Fill spa with water to water line mark on Weir door.

The water level must be measured with no one in the spa. The space from the water to the top lip of the spa allows for the water to rise as people enter the spa without it overflowing. Operating the spa when the water level is low can damage the pump and heater and could cause a fire.

Careful attention must be paid to filling with water and bleeding air from the plumbing system every time the spa is drained.

1. Turn OFF all electrical power to the Equipment Pak.
2. Turn the thermostat to the OFF position.
3. Open both slice valves to allow water to flow into the equipment Pak and plumbing system.
4. Fill spa with water and check all plumbing connections for leaks before continuing.
5. With the thermostat in the OFF position, move the Main Power Switch to the ON position. The Pump and/or the Air Blower will start in one of the modes as described under spa side control functions.
6. Select Therapy mode, let the system run on this mode for a few minutes to bleed air out of the plumbing system. If the system does not prime after 4 minutes of running, turn the system off. See "Priming Spa", page 19. **DO NOT RUN DRY** for extended periods or you **WILL** permanently damage the pump.
IMPORTANT NOTE: Only after full water flow has been established should the thermostat be turned on.
7. Test and reset G. F. C. I.
8. Refer to timer and operating instructions.

NOTE: The Equipment Module must never be operated without water in the spa. Serious damage to the heater and/or pump could result.

OPERATING INSTRUCTIONS

SPA SIDE CONTROL FUNCTIONS

TOP SIDE CONTROLS (Shown Below)

The top side controls activate the different modes of operation, and depending on the model, the lights and temperature of the spa.

FUNCTION BUTTON/PUMP BLOWER BUTTON

Activates the modes of operation as described on the following page. These functions are specific to the model and the electrical hookup.

LIGHT BUTTON (except model 80)

Activates the underwater light (and the pedestal lights on 300 series models only).

THERMOSTAT/TEMPERATURE SET

Controls the heater over a range of approximately 50 degrees to 104 degrees. Voltage and altitude, as well as movement during transportation, may affect the accuracy of your thermostat. Fully turned counterclockwise, the thermostat is off. Models 80, 180, 120 and 155 have a thermostat on the heater unit instead of on the topside control.

FREEZE PROTECT (300 and 200 series models)
At this setting the spa pump will cycle on and off to prevent freezing and will maintain a water temperature of approximately 50 degrees. During extreme cold, refer to Heating Timeclock, page. 13.

AIR/THERAPY CONTROLS

Allows air into jets, for adjustable vigorous water action.

THERAPY SELECTOR KNOB (300 and 200 series models)

Allows the choice of which jets will operate.

READY LIGHT (300 and 200 series models)

Lights when the desired water temperature has been reached.

HEATER LIGHT (300 and 200 series models)

Lights when the heater is on.

HI-CIRC LIGHT (300 and 200 series models)

Lights when the high speed pump (jets) is on.

BUBBLER LIGHT (300 and 200 series models)

Lights when the air blower is on.

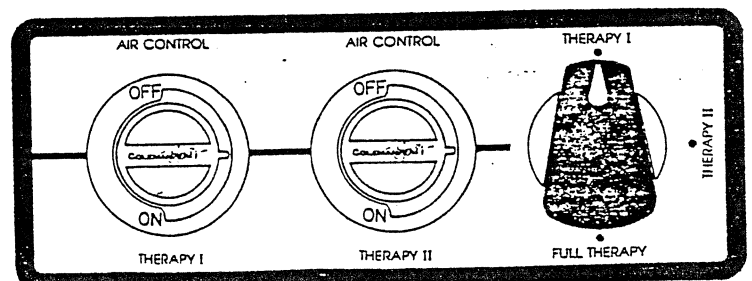
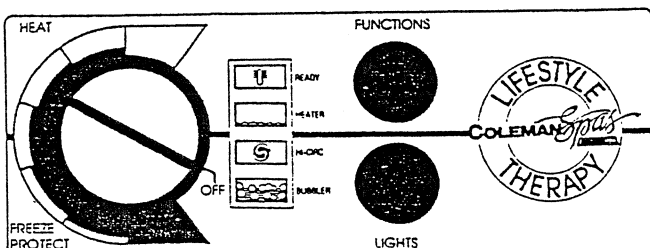
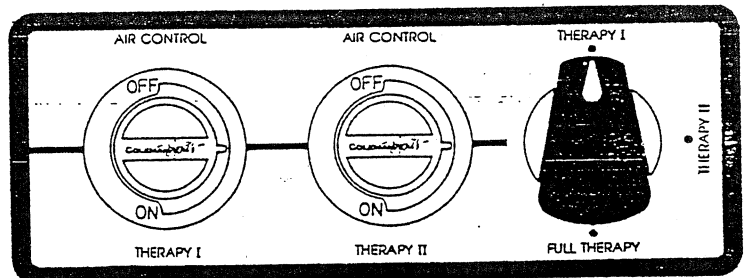
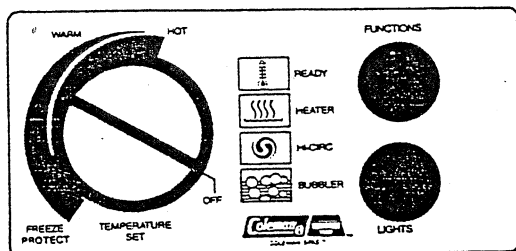
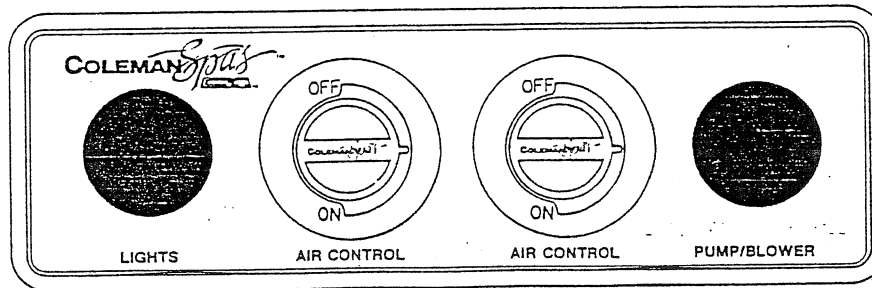



OPERATING INSTRUCTIONS

An air-activated control center is mounted on the lip of the spa for your safety and ease of operation. Each time the control function button is depressed, the switching mechanism will advance to the next Mode in the continuous sequence. Do not hold the button down. Push and release.

For optimum performance and long-lasting equipment life, pause briefly (one to two seconds) between push button selections.

120 VOLT OPERATION 300 SERIES

- MODE 1 Pump operates in LOW speed as determined by the setting of the FILTERING time clock. Heater operates as determined by the setting of the HEATING time clock and thermostat.
- MODE 2 Pump operates in HIGH speed. Air Blower operates in HIGH speed. Heater will not operate.
- MODE 3 Pump operates in HIGH speed. Air Blower operates in LOW speed. Heater will not operate.
- MODE 4 Pump operates in HIGH speed. Heater will not operate.

120 VOLT OPERATION 100 and 200 SERIES

- MODE 1 Pump operates in LOW speed as determined by the setting of the FILTERING Time clock. Heater operates as determined by the setting of the HEATING time clock and thermostat.
- MODE 2 Pump operates in HIGH speed. Air blower operates. Heater will not operate.
- MODE 3 Pump operates in HIGH speed. Heater will not operate.
- MODE 4 Air Blower operates alone. Heater will not operate.

120 VOLT OPERATION MODEL 80 ONLY

- MODE 1 Pump operates in LOW speed. Heater operates as determined by the thermostat setting.
- MODE 2 Pump operates in HIGH speed. Heater will not operate.

240 VOLT OPERATION MODEL 80 ONLY

- MODE 1 Pump operates in LOW speed. Heater operates as determined by the thermostat setting.
- MODE 2 Pump operates in HIGH speed. Heater will operate as determined by the thermostat setting.

240 VOLT OPERATION 300 SERIES

- MODE 1 Pump operates in LOW speed as determined by the setting of the FILTERING time clock. Heater operates as determined by the setting of the HEATING time clock and thermostat.
- MODE 2 Pump operates in HIGH speed. Air Blower operates in HIGH speed. Heater will operate as determined by the thermostat setting.
- MODE 3 Pump operates in HIGH speed. Air Blower operates in LOW speed. Heater will operate as determined by the thermostat setting.
- MODE 4 Pump operates in HIGH speed. Heater will operate as determined by the thermostat setting.

240 VOLT OPERATION 100 and 200 SERIES

- MODE 1 Pump operates in LOW speed as determined by the setting of the FILTERING time clock. Heater operates as determined by the setting of the HEATING time clock and thermostat.
- MODE 2 Pump operates in HIGH speed. Air blower operates. Heater will operate as determined by the thermostat setting.
- MODE 3 Pump operates in HIGH speed. Heater will operate as determined by the thermostat setting.
- MODE 4 Air Blower operates alone. Heater will not operate.

NOTE: All spas (except model 80) are equipped with a built-in Electronic "Comfort Timer". After 30 minutes of operation in MODE 2, 3, or 4 the unit automatically switches to MODE 1. Pushing the spa side air button one time will return the unit to the MODE OF OPERATION prior to automatically switching to MODE 1.

OPERATING INSTRUCTIONS

SETTING THE TEMPERATURE

The thermostat will control the electric heater in Mode 1 only when spa is wired for 120 volt operation. When wired for 240 volt operation, the thermostat will control the electric heater in Modes 1, 2 and 3 on 100 and 200 series spas and in all modes on 300 series spas.

The thermostat adjustment knob on the 200 and 300 series is located on the spa side control panel. Review start up procedures page 14. The thermostat control knob for the 100 series is located in the equipment box. Open door, move knob to hot range, close door, and heating mode will start. Rotate the knob to the center of the hot range. This setting will cause the water temperature to rise to 95 to 100 degrees F. Do NOT expect to feel hot water coming from the jets! Turning the thermostat control to high will not heat the spa faster. It only controls the maximum temperature of the spa water.

Your spa will heat approximately 2 to 3 degrees per hour when wired for 120 volts, and 8 to 10 degrees per hour when wired for 240 volts.*

*Spa Thermal Cover installed. Heating times are approximate.

If the water temperature reaches a level higher than you wish, turn the thermostat knob back to a lower setting. The spa's water temperature will stabilize. When the water temperature falls below the temperature set on the thermostat, the heater and pump will again cycle ON and OFF as needed to maintain preset temperature.

The length of time it takes the water to reach the desired temperature depends upon several factors: water temperature at start, ambient air temperature, spa gallonage, relative humidity, type and insulative qualities of the spa cover and input voltage of electric power applied. Also be aware that prolonged use of the air blower and hydro jets when using the spa will have a significant cooling effect on the water.

A spa cover will help control heat loss from the water's surface. It will also improve the spa heater's efficiency if you keep the spa cover in place while heating the water.

Ambient air temperature may affect your spa temperature in other ways also. The pump and blower are motors that will generate heat. This heat has nothing to do with the thermostat or heater, but in some situations may raise the

temperature of your spa. This is especially noticeable when the ambient air temperature is high and the pump is being used for long periods of time. Should you find this occurring, review how your timeclocks are set and how many hours a day you are running the spa. Decreasing the running time should bring the temperature back to normal. Also review the notes on blower temperature on page 10.

HELPFUL HINTS

Choose the desired control function using the air-activated button. Each time the button is pressed, the system advances to the next mode in sequence (See page 16)*. Select the appropriate mode, relax and enjoy. When you are through, return the system to the heat/low pump mode, close air control valves, and replace cover.

*When pushing the air button to change modes it is always wise to wait 2 seconds before pushing the button again. This allows the pump starting switches to operate without being stressed.

Normal unattended operation of the spa is with the Equipment Pak in the heat/low pump mode. Water temperature is automatically maintained by the properly set (through trial-and-error and personal preference) thermostatically controlled heater and/or time clock setting. Maximum temperature available is 104 degrees F.

The air blower should be used only when people are in the spa to minimize heat loss and prevent chemical dissipation.

JET AND THERAPY CONTROL

The level of jet action is determined by the amount of air entering the therapy jets (should be closed when heating). The air therapy controls, located on the lip of the spa, establish this level by increasing or decreasing the air to the jets.

THERAPY JETS

The therapy jets, which are directional, return water into the spa from the equipment. A turbulent flow of water mixed with air will provide a concentrated body massage.

MICROSSAGE JETS

These rotating jets operate in conjunction with the therapy jets. Should the jet cease to spin there may be an obstruction which needs to be removed. Rotate the jet face counter clockwise and remove. Turn on the pump for a minute to clear the jet of any debris. Check the jet for hair or debris. Reinstall the jet face by turning clockwise until the tabs lock into place. Scaling can also cause jets not to run. Check water chemistry for high pH.

WHIRLPOOL JETS

(200 and 300 series only)

The whirlpool jets provide a high volume circular water flow.

AIR/THERAPY CONTROLS

The level of jet action is determined by the amount of air entering the jets (should be closed when heating). The air mixture controls, located next to the spa side controls, establishes this level by increasing or decreasing the air to the jets.

THERAPY SELECTOR KNOB

(200 and 300 series models)

Enables you to choose one of 3 therapy settings. Therapy 1 controls a combination of therapy and microassage jets. Therapy 2 controls 2 whirlpool jets or additional therapy and/or microassage jets depending on model. Full therapy powers all jets.

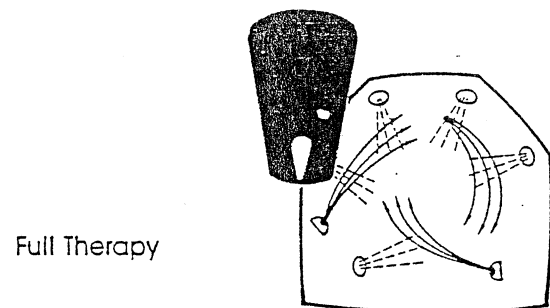
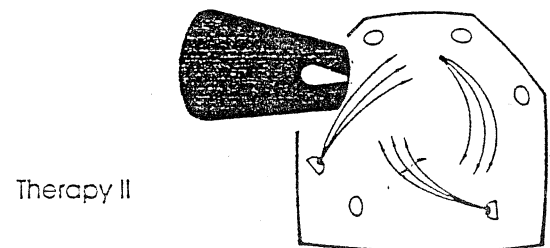
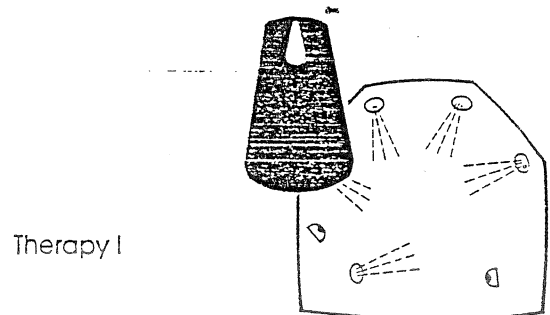

MAINTENANCE

SPA CABINET CARE

Your custom spa cabinet is made from quality handcrafted redwood. It has been coated with a seal and stain prior to spa assembly to preserve its appearance and help prevent weathering. Further wood protection requirements depend on spa location (indoors or outdoors, sun, shade, etc.), and local climate conditions. Re-treat with an appropriate product recommended by your authorized dealer upon installation and 3-4 times per year.

Cleaning the spa cabinet: Rinse dirt and dust regularly with clear water. To remove stubborn dirt, grime, and mild discoloration, wash with a mild detergent and warm water.

DRAINING SPA

Always turn the spa heater off when you drain your spa. Do not turn it back on until you have full flow coming out your jets for several minutes.

The water level in the spa must be kept at its normal level water line mark. Note: evaporation and splashing will cause the water level to drop.

Concentrations of impurities from evaporation, body oils, perfumes, and winds, etc., accumulate in the spa and cannot be filtered out. Consequently, it is necessary to drain your spa and refill it with fresh water every six to eight weeks or more often, depending on the amount of use.

To drain the spa, first switch the Equipment Pak to the standby mode and unplug the cord. If your spa is wired for 240 volt operation, turn circuit breaker off. Then attach a garden hose to the spa drain faucet and open the valve. Do not use the pump to drain the spa.

After draining the spa using the drain hose in the equipment compartment (open ball valve), clean the spa shell, skimmer and filter.

PRIMING SPA

Be aware that after draining and refilling your spa you may need to discharge air in the system in order for the pump to operate again. Should you experience this air-lock, there are two options to relieve it. 1) You can crack or loosen the union in front of the pump to release the air or 2) you can remove the filter and insert a garden hose into the center hole and flush water through the system.

If power was turned off for draining, you must reset timeclocks.

WATER TESTING AND CHEMICAL TREATMENT

Water chemistry is critical in a spa system much more so than in an ordinary swimming pool. The combination of high temperature and small volume of water means that the chemical balance must be watched carefully, which is why a chemical start up kit should be purchased from your Coleman Spas dealer. The instructions should be followed routinely; ignoring them may damage or corrode your support system equipment. Keep your chlorine residual at 1.0 to 2.0 parts per million. Chlorine tests should be done daily with your test kit (more frequently with heavy usage).

The pH balance should be maintained between 7.2 and 7.6, and is adjusted by the addition of pH up or pH down. We do not recommend the use of muriatic acid in your spa because of its corrosive effects on the nonporous surface of your spa and its metal parts. If you must use acid to correct the pH, use only the dry type and dissolve it in water prior to adding it to the water in the spa. **NEVER MIX TWO CHEMICALS TOGETHER. NEVER STORE ANY CHEMICALS IN THE EQUIPMENT COMPARTMENT.**

CLEANING

Your spa shell is formed by two layers of plastic material. The smooth top surface is made of tough long lasting acrylic and contains concentrated color. This acrylic surface is supported by a structural layer of fiberglass-reinforced polyester resin of substantial thickness. A chemical reaction occurs during manufacture that bonds these layers permanently into a hard, strong substance. A minimum amount of care and cleaning will keep your spa looking new for years.

To clean your spa, use a mild, non-abrasive liquid detergent, isopropyl alcohol, or commercially prepared spa cleaner. Do not use abrasive cleaners. Check with your dealer for approved cleaning materials, such as Lime-Away®.

You can protect and restore the gloss to a dulled surface by using a product designed specifically for use on acrylic finishes, such as an acrylic polish.

Use a spa cleaner for residue and lime buildup at the water level of the spa surface. This can be applied to the acrylic surface with a soft cloth and wiped clean. Use small amounts to avoid polluting spa water. It may be necessary to lower the water level 2 to 3 inches before cleaning if heavily soiled at the waterline.

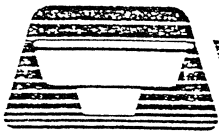

FILTER MAINTENANCE

The removable filter cartridge is located in the filter cannister behind the skimmer. The filter should be inspected at least monthly during normal use, and more often when spa use is heavy.

Keep the filter clean! A clogged filter decreases both performance and water quality.

To clean the filter, simply follow these steps:
(Note: it is not necessary to drain the spa.)

1. Turn power switch to the standby position.
2. Remove round skimmer lid on top of spa.
3. Remove strainer basket.
4. Remove filter cartridge from the filter cannister by grasping the handle on top, unscrewing it counterclockwise, and lifting out.
5. Soak and hose out filter cartridge, unless replacing with new cartridge.
6. Place filter cartridge back into filter cannister, and screw back in clockwise with handle until snug. Do not overtighten. When the spa is empty the Weir door will block the filter cannister. You must hold it out of the way when reinstalling the cartridge. When the tub is full of water the door will float so you will have easy access for installing the filter cartridge.
7. Replace strainer basket and skimmer lid.
8. Turn the power switch to the ON position.

In addition to performing normal filter maintenance, it will be necessary to occasionally remove oils that coat the filter reducing filter flow. To remove these oils, soak the cartridge in a plastic pail containing a commercial filter cleaning solution (available from your Coleman Spas dealer or most pool supply stores). Follow the manufacturer's instructions for use.

We suggest that you replace your filter cartridge yearly to maintain optimum performance.

WINTERIZING

In cold climates where freezing temperatures occur, special care is required to prevent the possibility of damage to the spa and equipment due to freezing.

If you plan on using your spa during cold months, be sure your pump and heater are in good working order. The spa shell has been insulated to provide efficient operation in cold weather areas.

SPECIAL NOTE: IF YOU DO NOT INTEND TO USE YOUR SPA DURING THE WINTER MONTHS AND THERE IS DANGER OF FREEZING, THE SPA MUST BE WINTERIZED! YOU MUST DO THE FOLLOWING:

1. Shut off all electrical power to the portable[®] spa.
2. Drain spa of all water. If you cannot draw off all of the water (especially from hoses) R.V. antifreeze should be added to the remaining water. If anti-freeze is used, it should be an inhibitor Propylene Glycol such as Dow Frost available through Dow Chemical Distributors.
3. Be sure to drain all drain hoses.
4. The filter should be drained, and cartridge removed and cleaned.
5. Check to see that there is no water in the heater element chamber and air blower elbow.
6. Clean your spa as per previous maintenance instructions.
7. Cover your spa with a waterproof, water-shedding, impenetrable cover.
8. For further information on blowing out the plumbing lines and winterizing procedures, contact your local dealer.

NOTE: If you elect not to drain your spa and the temperature is going to be below freezing for extended periods of time, especially 0 and sub zero, it is best to operate the spa pump on continuous. If the tub is not going to be used and kept in the 100 range you may have problems if your power goes out. It is wise during these bad weather periods to set the thermostat higher. This will keep the spa water from freezing quickly if you have a power failure.

LIGHT BULBS

Spa light bulb is serviceable from behind only. Remove closest panel to access the bulb.

Perimeter light bulbs (300 series only) are also serviced by removing the panel.

PROBLEM SOLVING GUIDE

PROBLEM	USUAL CAUSE	SOLUTION
1. System not operating.	<ul style="list-style-type: none"> A. Equipment panel door off or out of alignment. B. House circuit breaker tripped or in OFF position. C. G. F. C. I. on face of spa pak tripped. D. Power cord not connected to outlet. 	<ul style="list-style-type: none"> A. Put equipment panel door in place. B. Reset circuit breaker on home breaker panel. C. Push G. F. C. I. reset on. D. Connect power cord to outlet.
2. Heater not functioning.	<ul style="list-style-type: none"> A. Heater mode not selected. B. No power to heater. C. Thermostat set lower than water temperature. D. High limit safety switch tripped. E. Heater not operating. F. Heater element leaking. 	<ul style="list-style-type: none"> A. Select HEATER/FILTER mode #1. B. Check house circuit breaker and G. F. C. I. Be sure equipment cabinet door is in place. C. Turn to desired temperature. D. Push the red reset button on heater after water has cooled; contact dealer if switch continues to trip. E. Contact dealer. F. Contact dealer.
3. Water not clean.	<ul style="list-style-type: none"> A. Clogged or blocked floor suction or skimmer. B. Filter clogged (dirty). C. Poor water chemistry. D. Insufficient filtering time. E. Improper maintenance. F. High content of solids in water. 	<ul style="list-style-type: none"> A. Clean floor suction/skimmer. B. Clean or replace. C. See "Chemical Treatment" section. D. Run filtration mode longer. E. See maintenance section. F. Use clarifier or drain and refill spa.
4. Abnormal water usage.	<ul style="list-style-type: none"> A. Leak in system plumbing. B. Excessive evaporation and/or splashing. 	<ul style="list-style-type: none"> A. Repair leak. B. Use spa cover; lower thermostat setting.
5. Overheating	<ul style="list-style-type: none"> A. High ambient temperature. B. Excessive use of pump. C. Faulty contactors. 	<ul style="list-style-type: none"> A. See page 5. B. Use timeclock to run pump. C. Contact dealer.

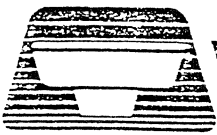

PROBLEM SOLVING GUIDE

PROBLEM	USUAL CAUSE	SOLUTION
6. Low water flow from jets.	A. Operating in FILTER mode #1. B. Clogged or blocked suction or skimmer. C. Dirty filter. D. Suction or discharge line partially plugged. E. Slice valves partially or fully closed. F. Pump running at sub-normal speed. G. Worn or damaged pump seal.	A. Select Therapy II or Full Therapy. B. Clean floor suction/skimmer. C. Clean or replace. D. Contact dealer. E. Open slice valves. F. Contact dealer. G. Contact dealer.
7. No water flow from jets.	A. Unit not plugged in. B. Selector switch is OFF. C. House circuit breaker tripped, no power to system. D. Equipment panel door open or not in place. E. Slice valves closed. F. G. F. C. I. tripped. G. Faulty pump or motor.	A. Plug unit in. B. Select other function. C. Reset circuit breaker at home panel. D. Put equipment panel door in place. E. Open slice valves. F. Reset G. F. C. I. G. Contact dealer.
8. Noisy pump and motor.	A. Clogged floor suction or skimmer. B. Leakage of air into suction line. C. Low water level. D. Damaged or worn motor bearings. E. Impeller rubbing inside case. F. Debris inside pump. G. Intake slice valve closed.	A. Clean floor suction/skimmer. B. Locate and repair leaks. C. Add water to normal water level (6" below lip). D. Contact dealer. E. Contact dealer. F. Contact dealer. G. Open both slice valves.
9. Water leakage at pump shaft (rotating connection between pump and motor).	A. Worn or damaged pump seal.	A. Contact dealer.
10. No air flow from jets.	A. Air control not open. B. Jet nozzle not seated properly. C. Jet nozzle missing.	A. Open control. B. Check jet nozzles. C. Inspect jets.

PROBLEM SOLVING GUIDE

PROBLEM	USUAL CAUSE	SOLUTION
11. Motor will not operate.	A. Main power switch in STANDBY.	A. Turn power switch ON.
	B. House circuit breaker tripped or in OFF position.	B. Reset circuit breaker.
	C. Equipment panel door not in place.	C. Put equipment panel door in place.
	D. G. F. C. I. tripped.	D. Reset G. F. C. I.
	E. Improper or defective wiring.	E. Contact dealer.
	F. Thermal Overload Protection switch tripped.	F. Auto reset after motor has cooled. Contact dealer if motor continues to cycle.
	G. Inadequate electrical supply.	G. Contact dealer.
	H. Locked shaft or impeller.	H. Contact dealer.
	I. Motor windings burned out.	I. Contact dealer.
	J. Defective starting switch inside motor.	J. Contact dealer.
	K. Motor overload condition.	K. Let cool for one hour. Motor overload will reset; if problem persists contact dealer.
	L. Mode switch failure.	L. Contact dealer.
	12. Blower motor will not operate.	A. OFF mode selected.
B. House or panel mounted circuit breaker tripped or in OFF position.		B. Reset circuit breaker on Equipment Pak face on Home circuit breaker panel.
C. Equipment panel door not in place.		C. Put equipment panel door in place.
D. G. F. C. I. tripped.		D. Reset G. F. C. I.
E. Improper or defective wiring.		E. Contact dealer.
F. Inadequate electrical supply.		F. Contact dealer.
G. Motor winding burned out.		G. Contact dealer.
H. Defective Thermal overload switch inside motor.		H. Contact dealer.
I. Brushes worn.		I. Contact dealer.
13. Black powder film around water line	A. Wearing in of blower brushes	A. Will disappear after use.

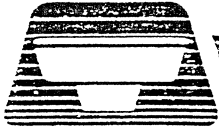

LIMITED WARRANTY SUMMARY

Please see the Warranty Card included with your product for complete warranty information.

Coleman Spas, Inc. provides a limited warranty to our customers. It applies to the spa structure, surface, most plumbing, the pump, heater, blower, and controls.

The warranty has limitations. These include improper maintenance, improper installation, misuse, abuse, accident, fire, normal wear and tear or improper water maintenance. Unauthorized modifications of the spa may void the warranty. Replacement costs associated with transportation, removal, and reinstallation are the sole responsibility of the spa owner.

SPA SOAKING GUIDELINES

1. Persons with heart disease, diabetes, high or low blood pressure or any serious illness, and pregnant women should not enter a spa without prior consultation with their doctor.
2. People with skin, ear, genital or other body infections, open sores or wounds should not use the spa because of the possibility of spreading infection.
3. Before entering, look at the water in your spa. If there is cloudiness or foaming, or if a strong chlorine smell is present, the water needs treatment. Soaking in such water greatly increases your chances of getting a skin rash (pseudomonas). Be sure to maintain the water properly. Ask your Authorized Coleman Spas Dealer for guidance.
4. Shower with soap and water before and after using the spa. Showering before use washes away many of the common skin bacteria, and removes lotions, deodorants, creams, etc. Perspiration and lotions will reduce the effectiveness of the disinfectant and lessen the ability of the filter to work efficiently.
5. Enter the spa slowly and cautiously. Be careful of your footing, and allow your body to gradually get used to the water temperature. Leave slowly as well, because your leg muscles may be sufficiently relaxed to make you a bit unsteady, and you may become lightheaded.
6. Soaking for too long makes some people nauseous, dizzy, lightheaded or faint. **DON'T SOAK FOR MORE THAN 15 MINUTES AT ONE SITTING IN 104°F (40°C) WATER.** If you wish to soak for a longer period of time in high temperatures, leave the spa after 15 minutes, shower, cool down and then return for another brief stay. In lower temperatures (e.g. 98.6°F - normal body temperature) most people can comfortably and safely soak for longer periods at one sitting. If you have any questions about what's right for you and your family, consult with your doctor.
7. Keep an accurate thermometer in the spa at all times to monitor the water temperature. Be sure you check the water temperature before and while in the spa.
8. Never use the spa while under the influence of alcohol.
9. With any drug or medication, consult with your doctor about potential harmful effects from combined use of the drug and hot water soaking.
10. Never use the spa when you are alone, for safety's sake.
11. Never allow children to use the spa unsupervised.

COLEMAN *Spas*™
Coleman Spas

P.O. Box 2920
Chandler, Arizona 85244-2920

© 1990 COLEMAN SPAS, INC.

