

Horizon & Spectrum Series



Owner's Manual

IMPORTANT SAFETY INSTRUCTIONS

When installing and using this electrical equipment, basic safety precautions should always be followed, including the following:

(1) **READ AND FOLLOW ALL INSTRUCTIONS.**

- (2) A green colored terminal or a terminal marked G, GR, Ground, Grounding, or the international symbol*  is located inside the supply terminal box or compartment. To reduce the risk of electric shock, this terminal must be connected to the grounding means provided in the electric supply service panel with a continuous copper wire equivalent in size to the circuit conductors supplying this equipment.

*IEC Publication 417, Symbol 5019.

- (3) At least two lugs marked “BONDING LUGS” are provided on the external surface or on the inside of the supply terminal box or compartment. To reduce the risk of electric shock, connect the local common bonding grid in the area of the hot tub or spa to these terminals with an insulated or bare copper conductor not smaller than No. 6 AWG.
- (4) All field-installed metal components such as rails, ladders, drains or similar hardware within 3m of the spa or hot tub shall be bonded to the equipment grounding bus with copper conductors not smaller than No. 6 AWG.

(5) **SAVE THESE INSTRUCTIONS.**

WARNING: Children should not use spas or hot tubs without adult supervision

and

AVERTISSEMENT: Ne pas laisser les enfants utiliser une cuve de relaxation sans surveillance

WARNING: Do not use spas or hot tubs unless all suction guards are installed to prevent body and hair entrapment

and

AVERTISSEMENT: Pour éviter que les cheveux ou une partie du corps puissent être aspirés, ne pas utiliser une cuve de relaxation si les grilles de prise d’aspiration ne sont pas toutes en place

WARNING: People using medications and/or having an adverse medical history should consult a physician before using a spa or hot tub

and

AVERTISSEMENT: Les personnes qui prennent des médicaments ou ont des problèmes de santé devraient consulter un médecin avant d’utiliser une cuve de relaxation

WARNING: People with infectious diseases should not use a spa or hot tub

and

AVERTISSEMENT: Les personnes atteintes de maladies infectieuses ne devraient pas utiliser une cuve de relaxation

WARNING: To avoid injury exercise care when entering or exiting the spa or hot tub

and

AVERTISSEMENT: Pour éviter des blessures, user de prudence en entrant dans une cuve de relaxation et en sortant

WARNING: Do not use drugs or alcohol before or during the use of a spa or hot tub to avoid

unconsciousness and possible drowning

and

AVERTISSEMENT: Pour éviter l’évanouissement et la noyade éventuelle, ne prendre ni drogue ni alcool avant d’utiliser une cuve de relaxation ni quand on s’y trouve

WARNING: Pregnant or possibly pregnant women should consult a physician before using a spa or hot tub

and

AVERTISSEMENT: Les femmes enceintes, que leur grossesse soit confirmée ou non, devraient consulter un médecin avant d’utiliser une cuve de relaxation

Warnings

WARNING: Water temperature in excess of 100.4°F (38° C) may be injurious to your health and

AVERTISSEMENT: Il peut être dangereux pur la santé de se plonger dans de l'eau à plus de 38° C

WARNING: Before entering the spa or hot tub measure the water temperature with an accurate thermometer and

AVERTISSEMENT: Avant d'utiliser une cuve de relaxation mesurer la température de l'eau à l'aide d'un thermomètre précis

WARNING: Do not use a spa or hot tub immediately following strenuous exercise and

AVERTISSEMENT: Ne pas utiliser une cuve de relaxation immédiatement après un exercice fatigant

WARNING: Prolonged immersion in a spa or hot tub may be injurious to your health and

AVERTISSEMENT: L'utilisation prolongée d'une cuve de relaxation peut être dangereuse pour la santé

WARNING: Do not permit electric appliances (such as a light, telephone, radio, or television) within 1.5m of the spa or hot tub and

and

AVERTISSEMENT: Ne pas placer d'appareil électrique (luminaire, téléphone, radio, téléviseur, etc) à moins de 1.5, de cette duve de relaxation

WARNING: Maintain water chemistry in accordance with manufacturer's instruction and

AVERTISSEMENT: La teneur de l'eau en matières dissoutes doit être conforme aux firectives du fabricant.

HYPERTHERMIA

The causes, symptoms, and effects of hyperthermia may be described as follows. Hyperthermia occurs when the internal temperature of the body reaches a level several degrees above the normal body temperature of 98.6°F(37° C). The symptoms of hyperthermia include drowsiness, lethargy, and an increase in the internal temperature of the body. The effects of hyperthermia include

- (a) unawareness of impending hazard;
- (b) failure to perceive heat;
- (c) failure to recognize the need to exit spas;
- (d) physical inability to exit spa;
- (e) fetal damage in pregnant women; and
- (f) unconsciousness and danger of drowning.

WARNING: The use of alcohol or drugs can greatly increase the risk or fatal hyperthermia in hot tubs and spas and

AVERTISSEMENT: La consommation d'alcool ou de drogue augmente considérablement les risques d'hyperthermie mortelle dans une cuve de relaxation.

Contents

- Important Safety Instructions** 4
 - Hyperthermia 5
 - Do’s and Don’ts 5
- Spa System Components** 6
- Spa Components** 7
- Spa Installation** 8
 - Site and Positioning 8
 - Outdoor Installation 8
 - Indoor Installation 8
- Electrical Information** 8
 - Ground-Fault Circuit-Interrupter 8
 - Important Safety Instructions 9
 - Installation Options 9
 - Horizon 400 Series 9
 - Spectrum 200 Series 9
- Start Up Procedures** 10
- Operating Instructions** 11
 - Powerworks Horizon 400 Series
 - Control System 11
 - User’s Pads 11
 - Temperature – Setting 11
 - Time and Filtration Cycles 12
 - Preset Filter Cycles 12
 - Changing Filter Cycles 12
 - Ozone Operation 13
 - pH Sensor Operation 13
 - Panel Lock 13
 - Temperature Lock 14
 - Inversion Feature 14
 - Auxillary Panel 15
 - Powerworks Spectrum 200 Series
 - Control System 16
 - User’s Pads 16
 - Temperature – Setting 16
 - Filtration 17
 - Ozone Production 17
- Safety Features** 18
 - Automatic Time Outs 18
 - Horizon Series 18
 - Spectrum Series 18
 - Error Messages 18
- Jets, Air Controls and Air Injectors** ... 19
 - Jets 19
 - Comfort Collar™ Control 19
 - Air Controls 19
 - Air Injectors 19
- Maintenance** 19
 - Water Chemistry 19
 - Sanitizing 19
 - pH Level 20
 - pH Sensor Operation 20
 - Water Maintenance With the
 - Powerworks® Ozonator 20
 - Sanitizing With Ozone 20
 - Specialty Chemicals 20
 - Hot Water Guide 21
 - BioQuest 22
 - Spa Cabinet Care 22
 - Spa Surface Care and Cleaning 22
 - Filter Maintenance 23
 - Draining Spa 23
 - Drain Access 23
 - Priming Spa 23
 - Winterizing 24
 - Light Bulbs 24
- Problem Solving Guide** 25
- Spa Soaking Guidelines** 27
- Technical Specifications** 27
- Horizon 400 System Wiring Diagram** ... 28
- Spectrum 200 System Wiring Diagram** 29
- Safety Sign** 30
- Accessories** 31
- Notes** 32

IMPORTANT SAFETY INSTRUCTIONS

**Caution: Risk of electrical shock.
Read and follow all instructions.**

When installing and using this electrical equipment, basic safety precautions should always be followed, including the following:

1. **READ AND FOLLOW ALL INSTRUCTIONS.**
2. **Warning:** To reduce the risk of injury, do not permit children to use this product unless they are closely supervised at all times.
3. A wire connector is provided on this unit to connect a minimum No. 6 AWG (5.15 mm²) solid copper conductor between this unit and any metal equipment, metal enclosures of electrical equipment, metal water pipe, or conduit within 5 feet (1.5 m) of the unit.
4. **Danger:** Risk of Injury.
 - d) Never connect unit to a power supply with a load controller.

IMPORTANT SAFETY INSTRUCTIONS

5. **Danger:** Risk of Accidental Drowning. Extreme caution must be exercised to prevent unauthorized access by children. To avoid accidents, ensure that children cannot use this spa unless they are supervised at all times.
6. **Danger:** Risk of Injury. The suction fittings in this spa are sized to match the specific water flow created by the pump. Should the need arise to replace the suction fittings or the pump, be sure that the flow rates are compatible.

Never operate spa if the suction fittings are broken or missing. Never replace a suction fitting with one rated less than the flow rate marked on the original suction fitting.
7. **Danger:** Risk of Electrical Shock. Install at least 5 ft (1.5 m) from all metal surfaces. As an alternative, a spa may be installed within 5 feet

of metal surfaces if each metal surface is permanently connected by a minimum No. 6 AWG (5.15 mm²) solid copper conductor attached to the wire connector on the terminal box that is provided for this purpose.

8. **Danger:** Risk of Electric Shock. Do not permit any electric appliance, such as a light, telephone, radio, or television, within 5 ft (1.5 m) of a spa.

A licensed electrician should make the final electrical connections.

The electrical supply for this product must include a suitably rated switch or circuit breaker to open all ungrounded supply conductors to comply with section 422-20 of the National Electrical Code ANSI/NFPA 70-1987. This disconnecting means must be readily accessible for operation but installed at least 5 ft. (1.5 m) from the spa as required to comply with local code requirements.

9. **Warning:** To reduce the risk of injury:
 - a) The water in a spa should never exceed 104°F (40°C) . Water temperatures between 100°F (38°C) and 104°F (40°C) are considered safe for a healthy adult. Lower water temperatures are recommended for young children and when spa use exceeds 10 minutes.
 - b) Since excessive water temperatures have a high potential for causing fetal damage during the early months of pregnancy, pregnant or possibly pregnant women should limit spa water temperatures to 100°F (38°C) .
 - c) Periodically, before entering a spa, the user should measure the water temperature with an accurate thermometer since the tolerance of water temperature-regulating devices varies.
 - d) The use of alcohol, drugs, or medication before or during spa use may lead to unconsciousness with the possibility of drowning.
 - e) Persons suffering from obesity or with a medical history of heart disease, low or high blood pressure, circulatory system problems, or diabetes should consult a physician before using a spa.
 - f) Persons using medication should consult a

physician before using a spa since some medication may induce drowsiness while other medication may affect heart rate, blood pressure, and circulation.

10. **SAVE THESE INSTRUCTIONS.**

Do's and Don'ts

Do:

- Replace your cover immediately after use.
- Be aware of the dangers of a wet and slippery surface. Use caution when entering and exiting your spa.
- Have a **licensed electrician** make all final electrical connections.
- Keep your water chemistry correctly balanced. Untreated spa water will cause problems with your spa and equipment as well as being a health risk.
- Clean your filter monthly. (See filter maintenance pg. 23)
- It is recommended you position the spa in such a way as to leave adequate room to access all sides for maintenance purposes.
- Use a bathing cap with long hair.
- Refer to information on hyperthermia on this page.
- Use only genuine Coleman Spas' Spa Care products for the best performance and to keep your water properly balanced for years of enjoyment. (See p. 31)

Don't:

- Use the spa at 104°F (40°C) for long periods of time.
- Use an extension cord to power your spa.
- Allow anyone to stand on the spa cover. It is not designed to support weight.
- Power the spa unless it is filled with water to the water level mark on the Weir door.
- Operate the pump for extended periods of time with the cover in place. Extended operation can cause heat build-up and interfere with spa operation.

Hyperthermia

The causes, symptoms, and effects of hyperthermia may be described as follows: Hyperthermia occurs when the internal temperature of the body reaches a level several degrees above the normal body temperature of 98.6°F (37°C). The symptoms of hyperthermia include an increase in the internal temperature of the body, dizziness, lethargy, drowsiness, and fainting. The effects of hyperthermia include (1) failure to perceive heat, (2) failure to recognize the need to exit spa or hot tub, (3) unawareness of impending hazard, (4) fetal damage in pregnant women, (5) physical inability to exit the spa or hot tub, and (6) unconsciousness resulting in the danger of drowning.

Warning: The use of alcohol, drugs, or medication can greatly increase the risk of fatal hyperthermia.

Spa System Components



200 Series

400 Series

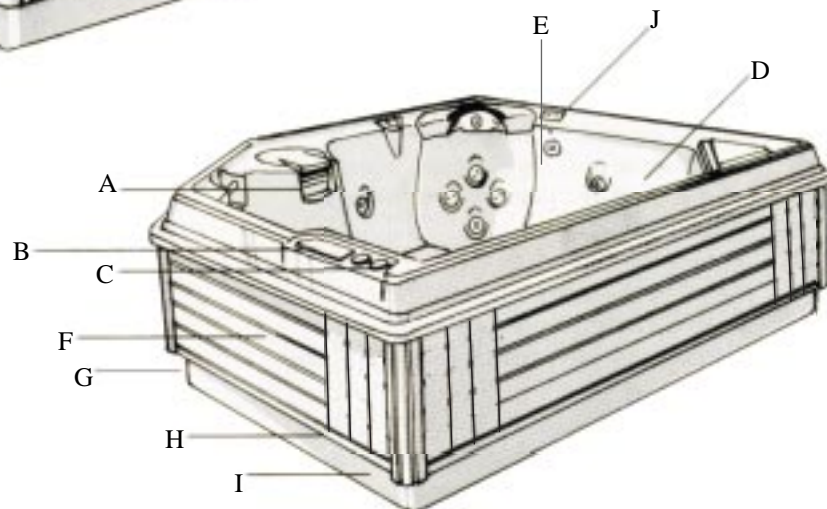

Spa System Components

A. Filter Skimmer/Weir Door:

Removes floating debris from the water surface, provides a water return path to equipment, and houses water filter element.

B. Spa Side Control Panel:

Used to control temperature setting, pump for jets, bubbler action, and light(s).

C. Air Controls:

Increases or decreases air entering the jets. Close during heating for maximum efficiency.

D. Diverter/Whirlpool (Horizon 400 Series only):

Directs the flow from the whirlpool jet to other jets.

E. Comfort Collar Valve (Horizon 400 Series only):

Turns the neck jets from high to low.

F. Equipment Pack Service Panel (no user serviceable parts):

Spa support system consisting of 2-speed pump or pumps, heater, air injectors, and associated electrical controls (not shown).

G. Drain Access (Adjacent to the equipment service panel):

Spa drain faucets.

H. Perimeter Lighting (Horizon 400 Series only):

Adds beauty and safety to your spa area. It will illuminate approximately three feet around the cabinet.

I. Manufacturer's Identification Label:

Contains identification information for warranty service.

J. Auxillary Control (Horizon 400 Series only):

Used to control the pumps from the therapy seat.

Spa Components

Reference only. Equipment is not always as shown.

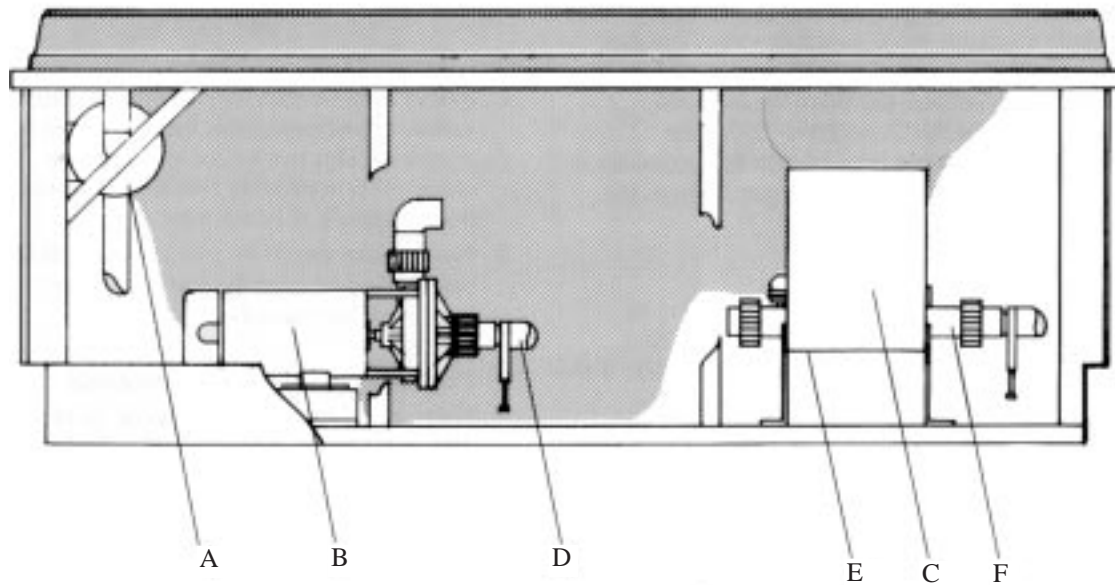

Note: No consumer serviceable parts.

- A. Air Injector:** Provides a large volume of air to the air injectors in the seats of the spa for a vigorous bubble action.
- B. Pumps:** Two on Spectrum 200B Series spas, two on Horizon 400 Series spas. Low speed for efficient water circulation during filtration and heating; high speed for maximum action of the jets. The pump functions are activated by topside controls.
- C. Warning and Installation Label:** Contains important safety information and installation instructions.
- D. Slice Valves (4 Total):** Shuts off water flow from the spa to the equipment while servicing. It must be open during normal operations.
- E. Electrical Connections:** The electrical plugs for the unit connect here. All existing connections should be intact.
- F. Heater Assembly:** Thermostatically controlled and equipped with an overheat safety shut-off.

Spa Installation

Danger: Risk of electrical shock. Install at least 5 feet from all metal surfaces.

The electrical supply for this product must include a suitably rated switch or circuit breaker to open all ungrounded supply conductors to comply with Section 422- 20 of the National Electrical Code, ANSI/NFPA70-1987. The disconnecting means must be readily accessible but installed at least 5 feet (1.5 meters) from the spa water.

Site and Positioning

Locate the spa on solid, level foundation or flooring. Keep in mind the weight of the filled spa (in excess of 4,000 lbs. on some models). If you have any doubts about the load bearing ability of your chosen site, contact an architect, your building department or a building contractor. The entire perimeter of the spa cabinet and the spa bottom must be evenly supported.

If your spa is installed outdoors, we recommend that you provide a concrete pad for the spa to rest on (8ft.x8ft.x4" level pad). Failure to provide a level surface could structurally damage your spa and will void the warranty.

The spa must be installed to allow access for service and maintenance; therefore, below grade level installation is not recommended.

Outdoor Installation

Keep the following additional factors in mind when installing your spa outdoors:

1. Local codes pertaining to fencing.
2. Local electrical and plumbing codes.
3. View from your house.
4. Wind direction.
5. Exposure to sunlight.
6. Location in regard to trees (falling leaves and shade).
7. Dressing and bathroom location.
8. Storage area for maintenance equipment and chemicals.
9. Location to facilitate adult supervision.
10. Landscaping and nighttime lighting.
11. Access to equipment cabinet panels.

12. Power supply location and foot traffic.

Indoor Installation

Keep the following additional factors in mind when installing your spa indoors:

1. Indoor spas promote high humidity, so a means of decreasing this humidity must be provided. This can be accomplished by using either ventilation fans or oversized de-humidifiers. Consult your dealer.
2. Floor drains must be provided to drain off water which may cause walking hazards and /or water damage.
3. Floor area should be flat and non-skid. No carpeting, ceramic tile is preferred.
4. Walls, ceilings, woodwork should be of materials capable of withstanding high humidity (redwood, cedar).
5. Be sure floor load bearing capacities are adequate to support the concentrated spa weight.
6. Spas should be double checked for leaks before installing to avoid possible water damage.
7. Indoor sunrooms are capable of maintaining high ambient temperatures which may effect the spa water temperature. It is not recommended that you operate your filter cycles for longer than 6 hours under these conditions.

Electrical Information

Caution: Risk of electrical shock. Read and follow all instructions.

Ground-Fault Circuit-Interrupter

A qualified licensed electrician shall connect the spa to a circuit protected by a GFCI. This is a requirement by the National Electric Code, ANSI/NFPA 70 and is also in compliance with Underwriter's Laboratories, Inc.

Important Safety Instructions

Prior to performing any service to the spa equipment, turn off all primary electrical power at the main circuit breaker or disconnect panel. All field electrical connections can be made by removing the front panel of the electrical control box. To gain access to the control box you must remove the exterior equipment access panel.

All electrical connections to this spa package must be accomplished by a qualified **licensed electrician** in accordance with the National Electrical Code and in accordance with local electrical codes in effect at the time of installation.

All connections should be made in accordance with the wiring diagram in the control box.

This equipment is designed to operate on 60Hz alternating current only, at a voltage of 240 volts as required.

Connections should be made using copper conductors only. The connecting wire and circuit breakers or fuses must all be sized to accommodate the Total Ampere load as specified on the equipment label.

ALL UNIONS MUST BE HAND-TIGHT AND ALL SLICE VALVES MUST BE LOCKED IN THE "OPEN" POSITION BEFORE FILLING OR REFILLING THE SPA!

Installation Options

Horizon Series

Spectrum Series

240 Volt Installation (only)

Models:

- All Horizon Series models.
- All Spectrum Series models.

Electrical Requirements:

- 240 Volts, 60Hz, Single Phase, 50 amp. or *30 amp GFCI, 3 wire service, including ground.

***30 Amp Option**

The heater can only be activated with the pump on low speed. Only the light can be operating at the same time without disabling the heater. See your authorized Coleman Spas dealer to select this option.

Units to be operated at 240 volts must have all electrical connections made by a qualified

electrician in accordance with the National Electric Code and in accordance with all local electrical codes in effect at the time of installation.

A hole can be drilled in the pedestal or base of the unit to bring the conduit to the equipment compartment. Care should be taken to avoid contact with critical components

Coleman recommends using copper line for all electrical connections.

Coleman spas installed for 240 volt operation require a 3 wire, 50 amp., 240 volt subfeed in non-metallic pipe to the spa equipment compartment (line 1, line 2, and ground). Refer to wiring diagrams on pages 28 & 29. A green colored terminal (or wire connector marked "G", "GR", "Grounding") is provided in the control box. To reduce the risk of electrical shock, connect this terminal or connector to the grounding terminal of your electrical service or supply panel with a continuous green insulated copper wire equivalent to the circuit conductor supplying this equipment. In addition, a second pressure wire connector is provided on the surface of the control box for bonding to local ground points. To reduce the risk of electrical shock, this connector should be bonded with a No. 6 AWG copper wire to any metal ladders, water pipes, or any metal within 5 feet of the spa.

The UL and the NEC (National Electric Code) both dictate that the amperage rating and the amperage requirements be listed on all electrical appliances. Coleman Spas, Inc. supplies both the rating and the requirements printed on our spas and in our manuals. The rating merely designates a class or range of amperages. For example, an appliance rated at 40 amps may actually draw as little as 36 amps or as much as 44 amps. But it is rated at 40 amps regardless. In contrast, the requirement listed on an appliance states the size of load that the wiring, overcurrent protective device, etc. must be capable of supporting in order to supply current to this appliance. This requirement includes a built-in safety factor. Home inspectors, licensed electricians, and UL technicians receive training explaining the difference between these two terms.

The NEC states: "The ampacity of the branch-circuit conductors, and the rating or setting of overcurrent protective devices, shall not be less than

Start Up Procedures

125% of the total load of the nameplate rating" see article 680-41h of the NEC and UL section 63.1.

(UL Device Rating) times 125% = (Device Requirements)

(40 Amperes) times 125% = (50 Amperes)

Therefore a spa with a rating of 40 amperes will need an overcurrent protective device and copper wiring capable of handling 50 Amperes.

Start Up Procedures

Follow recommendations for site location and electrical connection. The water line on the weir door (see skimmer, page 6) is the level at which the water should be maintained.

Note: Never operate the spa when the water level is below water level mark on weir door. It can damage the pumps and heater and is potentially dangerous.

1. Fill the spa through the filter hole to the water line on the weir door with tap water. Never use "softened" water in your spa.
2. Turn power on to unit at circuit breaker or disconnect.
3. Open the air controls and cycle the jets from high to low. Water should come from the therapy jets. If water flow is not established, turn off jets and see Priming Spa, page 23.

Important: Do not operate the spa without full water flow.

4. Add chemicals. See Chemical treatment and Water Maintenance section (page 19).

Follow Operating Instructions for your particular model and set the spa to heat to the desired temperature. Initially you may find that the spa requires 12 to 14 hours on 240 Volt installations to reach temperature. Keep your thermal cover on the unit and close the air controls to help the heating process.

Operating Instructions

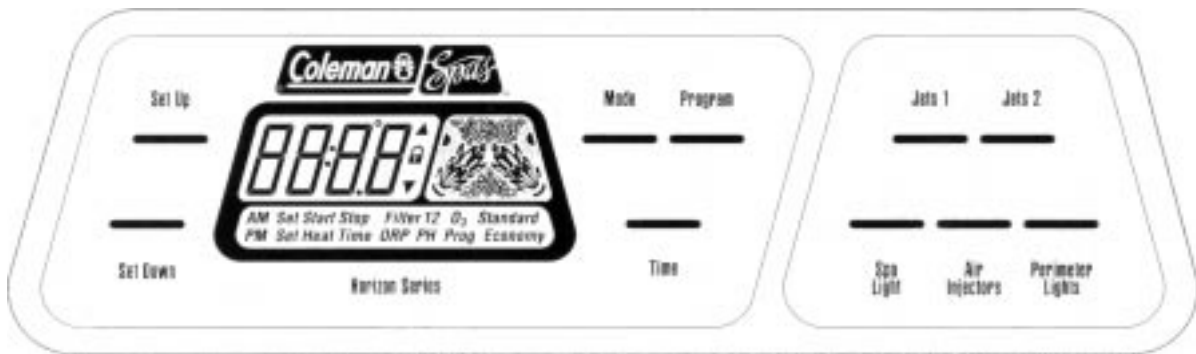



Powerworks Horizon 400 Series Control System



The Horizon Powerworks Control offers you the ultimate in spa control. The backlit, Liquid Crystal Display (LCD) displays current temperature and operating status. Each feature is actuated through the control panel pad. Simply touch the appropriate button to activate desired function.

At start up, when power is supplied to the spa, it will be necessary to set the time and filtration cycles. Default settings: ECON, 100°F(38° C), and filter between 2 AM-5 AM and 2 PM-5 PM.

User's Pads

- Program Pad**
 Used for initiating time setting, filter programming and panel lock.
- Mode Pad**
 Switches the spa from economy to standard mode and vice-versa. In economy mode, the spa will heat to set temperature only during the filter cycles. In the standard mode, the spa will be heated automatically to the set temperature. This pad also resets the control in the rare instance of an overheat.

Check your water temperature before you enter the spa

- Temperature Controls**
 When either of these pads are touched once, the LCD will display the temperature which has been set, as well as the words "set heat". Each time either of these pads is pressed again, the set temperature will increase or decrease, depending on which pad is pressed. After 3 seconds, the LCD will automatically display the spa temperature.
Note: Used with inversion feature.(see page 14)
Note: There is a temperature lock feature. (See the lock section, page 14.)
- Jets 1**
 The sequence of jet action is:
 1-Low whirlpool jets
 2-High whirlpool jets
 3-Off
- Jets 2**
 The sequence of jet action is:
 1-Low therapy jets
 2-High therapy jets
 3-Off

The low speed whirlpool is timed to automatically turn off after four hours of operation. The high speed whirlpool and therapy jets are timed to turn off automatically after thirty minutes of operation.

Note: The low-speed pump on Jets 1 will operate automatically whenever the heater is on, when a filter cycle is activated or when a freezing

Operating Instructions

condition is detected. When this automatic activation occurs, the low-speed pump cannot be deactivated by the “JETS” pad; however, the high-speed pump may be started.

**Air
Injector**

Air Injector

The Horizon Series spa has a variable three speed air injector.

The sequence is:

- 1-High
- 2-Medium
- 3-Low
- 4-Off

The air injector is timed to turn off automatically after 30 minutes of operation.

**Spa
Light**

Spa Light

Touch this pad sequentially to adjust the spa light. The Sequence is:

- 1-High
- 2-Medium
- 3-Low
- 4-Off

The spa light will automatically turn off after 60 minutes.

**Perimeter
Light**

Perimeter Light

Touch this pad to turn on the perimeter lights. Touch again to turn the lights off. The lights will automatically turn off after 4 hours.

Time

Time

Touch to view the time of day.

Touch again to view the set spa temperature. The current spa temperature display will automatically resume after five seconds.

Time and Filtration Cycles

This control has been specifically designed so that by simply connecting the spa to its properly grounded source and touching the mode pad, the spa will function properly and safely at 100°F. In this mode, all user pads will be completely functional. However, to fully utilize the unique capabilities of this control, it is important to set the time of day properly.

Setting The Time

Once the spa has been properly connected, notice

the “set time” message flashing on the LCD screen.

Touch **Time**

Then **Program**

Then **Set Up** **or** **Set Down**

After either pad is touched once, time will advance or decrease in one minute increments. Press either pad again to stop the display’s time setting cycle.

Touch **Mode** To exit “Set Time” procedure.

Preset Filter Cycles

Now that the time has been set correctly, your spa will automatically filter itself for a 3-hour period every 12 hours. Whenever a filter cycle is active, this automatic filtering sequence is indicated by the following messages on the LCD screen:

Filter 1

The first filter cycle is automatically activated at 2:00 a.m. and operates the low-speed pump until 5:00 a.m. The heater will operate in the economy mode.

Filter 2

The second filter cycle is automatically activated at 2:00 p.m. and operates the low-speed pump until 5:00 p.m. Again, the heater will operate in the economy mode. During this cycle, a short purge function occurs on the second pump, and the blower.

Changing Filter Cycles

If the preset times are inconvenient, if a different duration is preferred, or if you wish to leave the heater off during filtering, the following procedure can be used to change the automatic filter cycle settings.

Touch **Time** The center display will read actual time of day

Then
Program "Set Time"

Then
Program "Set Start Filter 1"

At this point, each time the program pad is pressed, the filter-start time, the heater-enable status, and the filter-stop time will be indicated on the LCD screen.

When the filter-start or filter-stop times are displayed on the screen:

Touch **Set Up** or **Set Down**

to reset the times.

When the "Set Heat" message is displayed:

Touch **Set Up** or **Set Down**

to set the center display to "on" or "off". In the "on" position, the spa will warm to the set temperature during the filter cycles. In the "off" position, the heater will not be activated during the filter cycles.

Note: Must be in the "on" position to use the heater in the Economy mode. The off setting does not affect Standard mode. In cold weather, we recommend using the standard settings.

After entering the filter-set routine, you must:

Touch **Program**

to proceed through all the start and stop times for both filter cycles. Just follow the same procedure to adjust the "Filter 2" settings.

Note: Under freezing conditions do not override the second filtration cycle.

To exit the filter-set procedure:

Note: At the start of the second filtration cycle pump 2 is activated and a short air injector cycle is run. This is to clear the water in the air injectors and ensure complete filtration

Note: To properly clean and maintain your spa, a filter time of at least six hours per day (total of both cycles) is recommended.

Touch **Mode**

and the LCD will display the current water temperature.

Clean Up Cycle

After periods of heavy use, turn the jets on to "low whirlpool" for a four-hour Clean Up Cycle.

Ozone Operation

Spas equipped with the optional Coleman Powerworks® Ozonator will produce ozone whenever the spa is in a timed filtration cycle. Activation of the low whirlpool jets via the "jets" pad will initiate filtration, but not ozone production. Activation of other functions during timed filtration cycles will suspend ozone production for 30 minutes from the last time a pad is touched.

pH Sensor Operation

Spas equipped with the pH sensor option will provide an accurate pH reading to assist water maintenance. To view pH, touch the time pad twice. Recommended range is 7.2 to 7.6. If the pH of the spa water is outside of this range, the display will alternately flash the current temperature and pH reading. If this occurs, add chemicals as necessary to bring the pH into range. See Winterizing (page 24) for information on special pH sensor care.

Locking Features

Panel Lock

To help prevent unauthorized use of your spa, the Horizon® Digital control has incorporated a unique panel locking system.

To lock the panel:

Touch **Program** **The Center Display will Read**

Program

LOC

Then **Mode**

Mode

0

Operating Instructions



This sequence must be done within **three seconds** to activate the Panel Lock feature. The center display will show the spa temperature along with the lock symbol. All the panel pads are now deactivated except the program pad, which is used to initiate the unlock sequence.

To unlock the panel:

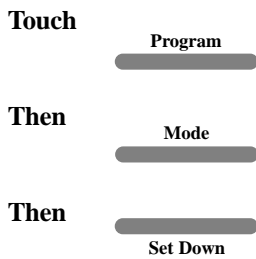

When the control panel lock is engaged, all automatic spa functions will operate normally but cannot be altered. To unlock the panel, the three pads must be pressed in the correct sequence and within **three seconds**. When the last pad is pressed, the lock symbol will disappear. All pads are now active.

Temperature Lock

This feature prevents unauthorized temperature adjustment of your spa water. While setting your spa water temperature, **after you have pressed either temperature pad**, follow the instructions below to lock your set temperature.

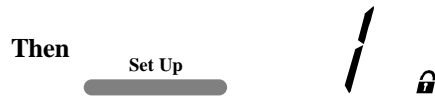
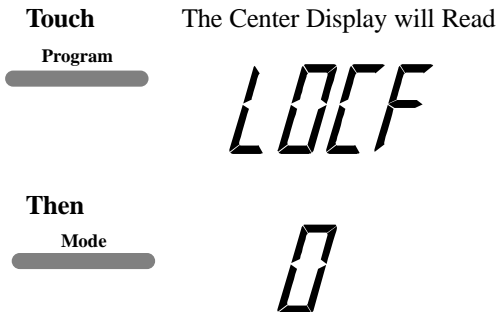
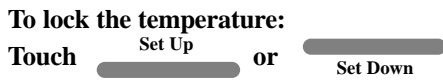

The set lock pads must be pressed within three seconds to activate the lock. Within **three seconds** the center display will show the spa temperature along with the lock symbol. The set temperature pads will be deactivated and when pushed, the set temperature will appear with a double arrow next to it.

To unlock the temperature:

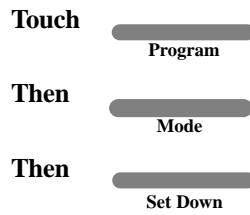

To unlock the panel, the three pads must be pressed in the correct sequence and within two seconds. When the last pad is pressed, the lock symbol will disappear. All pads are now active.

Inversion Feature

The alpha-numeric LCD display can be inverted in order to make reading the display while inside the spa easier. To invert the display:

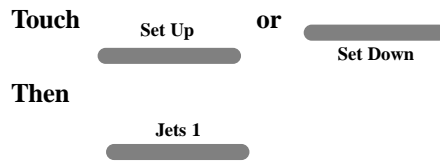

Auxillary Panel

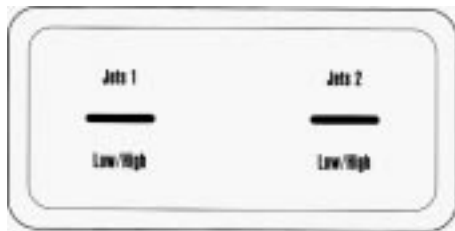

The auxillary panel controls the two jet pumps from the therapy seat. Touch each pad to control the pumps in the following sequence:

Jets 1 This pad controls the whirlpool jet action as follows:

- 1–Low whirlpool jets
- 2–High whirlpool jets
- 3–Off

Jets 2 This pad controls the therapy jet action as follows:

- 1–Low therapy jets
- 2–High therapy jets
- 3–Off

Operating Instructions

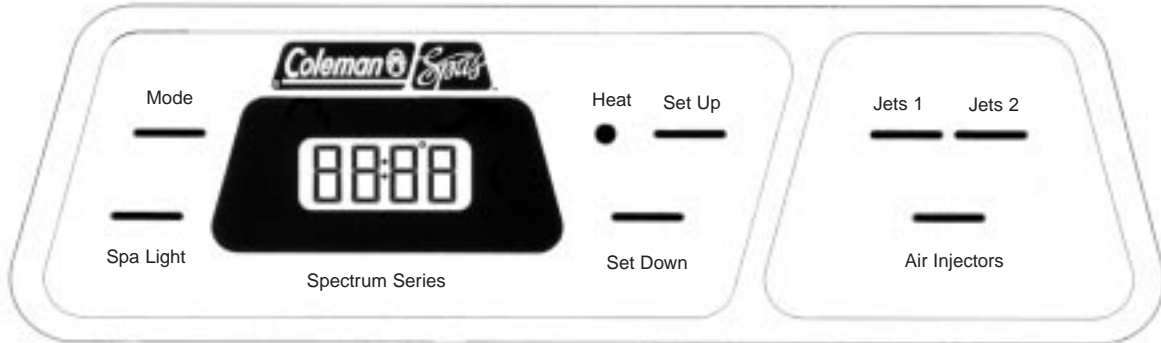

Powerworks Spectrum 200 Series Control System

The Powerworks Spectrum Control System activates the different modes of operation of your Spectrum series spa. Each feature is actuated through the control panel pad. Simply touch the appropriate button to activate desired function.

User's Pads

- Set Up Temperature**
The set temperature may easily be increased or decreased at any time.
- Set Down**
Both the current and set temperature will be displayed on the Liquid Crystal Display (LCD). The set temperature is differentiated by an arrowhead next to the number on the display. When the heater is operating, the RED "HEAT" LED will light up.

Note: Spectrum series spas that are wired 30amp will not heat when either the high pump or the blower is on.

- Jets 1 Jets**
Both the low-speed and high-speed pump may be activated by touching the "JETS" pad. The low speed jets,

on Jets 1, are timed to go off automatically after 4 hours. The low speed jets on Jets 2 and the high speed jets will go off automatically after 30 minutes. Touch the pad to reactivate.

Note: The low-speed pump on Jets 1 will operate automatically whenever the heater is on, when a filter cycle is activated or when a freezing condition is detected. When this automatic activation occurs, the low-speed pump cannot be

deactivated by the "JETS" pad; however, the high-speed pump may be started.

- Air Injector**
The air injector aerates the spa. The air injector is timed to stop automatically after 30 minutes. Touch the pad to reactivate.

- Light**
The spa light may be turned on or off by touching the "LIGHT" pad. The spa light will automatically turn off after 60 minutes of use.

- Standard/Economy Mode**
The spa may be switched from Standard to Economy mode and vice versa by touching the "MODE" pad. The topside will display "StAn" for 10 seconds and then revert to a numeric temperature display. In Economy mode the display will alternately flash "ECON" and the current temperature. In this mode the heater will only operate during the filtration cycles. In the Standard mode the heater will come on as necessary to maintain 100°F (38° C) or the set temperature at all times. Standard mode shows no additional display after switching from economy.



Standard will display "StAn" and Economy will display "Econ."

Preset Filter Cycles

The Spectrum has two preset filter cycles. The first cycle will begin immediately after power is provided to the unit. The second filter cycle will begin twelve hours after the first cycle. The factory preset cycles will be 3 hours each. The filter cycle duration can be adjusted to 1, 2, 3, 4, 5 or 6 hours.



Changing Filtration Cycles

Adjust the filter cycle duration to the desired time (1, 2, 3, 4, 5 or 6 hours) by using the following procedure:

Touch  or 

Then  The center display will read:



Then  or 

Adjust the cycle duration by pushing the set up or set down pad. Each press of the pad will display which filtration cycle you have chosen:

- FIL 1 1 Hours
- FIL 2 2 Hours
- FIL 3 3 Hours
- FIL 4 4 Hours
- FIL 5 5 Hours
- FIL 6 6 Hours

The change will begin immediately if the spa is in a filtration cycle or starting with the next filtration period, if it is changed outside of a filtration cycle.

To exit the filter-set procedure:

Touch 

Clean Up Cycle

After periods of heavy use, turn the Jets 1 on to “low speed” for a four-hour Clean Up Cycle.

Ozone Production

Spas equipped with the optional Coleman Powerworks® Ozonator will produce ozone during timed filtration cycles only. Activating the low speed jets via the “JETS” pad will initiate filtration but not ozone production. Activation of other functions during timed filtration cycles will suspend ozone production for 30 minutes from the last time a pad was touched.

When power is supplied to the spa it comes on in Economy - 100°F (38°C) with 3HR filtration beginning immediately.

Safety Features

Safety Features

Your Coleman spa is equipped with several safety features which are designed to protect the user and the equipment.

Automatic Time Outs

Horizon Series

The low speed whirlpool and the perimeter lights are timed to automatically turn off after four hours of operation. The high speed whirlpool, therapy jets and air injectors are timed to turn off automatically after thirty minutes of operation. The spa light will turn off automatically after 60 minutes.

Spectrum Series

The low speed pump 1 is timed to turn off automatically after four hours of operation. The high speed of the pumps and the air injectors are timed to turn off automatically after thirty minutes of operation. The spa light will turn off automatically after 60 minutes.

Error Messages

The following error messages are displayed on the LCD screen and describe the operating status.

Message	Meaning
	Overheat Protection There are two sensors on the system to detect overheating: a water temperature sensor and a hi-limit sensor. The water temperature sensor constantly monitors the spa water temperature. If the spa water reaches 112° F(44.4°C), the spa will be disabled. When the water cools below 110° F (43.3°C), the spa will automatically reset. The hi-limit sensor detects overheating of the heater element. If the temperature of the heater housing reaches 118° F (47.7°C), the spa will be disabled. This overheating condition may be caused by restricted water flow. When the water has cooled to 110° F (43.3°C), the spa may be reset from the panel by touching any pad.

Note: After a “OH” message, it is important that you check the water temperature before immersing yourself. If the “OH” message remains, the spa will not reset or the water doesn’t cool down, contact your dealer.

	Flow Switch The flow switch enables the
---	---

control to detect when the pressure switch has malfunctioned (not necessarily a pressure switch malfunction). Contact your dealer if a “FLO” message remains on the LCD.

	Flow Switch If the “FLO” message alternates with the temperature, you may have reduced water flow. Check for obstructions, closed slice valves, and a dirty filter.
---	---

	Temperature Set Back If the control detects that the spa water is 20° F (-6.7°C) cooler than the temperature set point, the heater will automatically activate to provide freeze protection. This is a normal spa function. No corrective action is necessary.
---	--

	Freeze Protection The spa software will automatically activate the low speed pumps to circulate the water when a freeze condition is detected (temperature of the heater element is below 40° F (4.4°C)). This is a normal spa function, no corrective action is necessary.
---	---

Note: Under freezing conditions do not override the second filtration cycle.

	Open Sensor Detection The hi-limit sensor is non-functional and the spa will be deactivated. Contact your dealer.
---	---

	Open Sensor Detection The water temperature sensor is non-functional and the spa will be deactivated. Contact your dealer.
---	--

Jets, Air Controls and Air Injectors

Jets

Coleman's jets are all individually engineered to provide a unique hydro-massage. All full sized and micro sized jets are completely adjustable. It is very important that you NEVER SHUT ALL FULL SIZED JETS OFF AT ONE TIME! The jet system is balanced so that all full size therapy jets are interchangeable (except the footjets on the Horizon series) and can be added in any quantity. Depending on the model, your spa will have a combination of the following jets.

Therapeutic (LS & Luxury): Targeting the larger muscle groups in the back and shoulders, the therapeutic jets deliver water flow for a wide, high-volume, soothing massage.

Turbo Swirl (LS & Luxury): A spinning, swirling jet giving a V-shaped water stream with a pulsating massage, strategically located to focus on muscle tension zones.

Diverter/Whirlpool: This jet creates soothing, overall water circulation, and it diverts water to other spa jets.

Note: Turn the diverter jet back clockwise for filtration cycles

Micro Therapeutic: Specially designed for the foot lounges and above the water line in the Comfort Collar, the micro therapeutic jet flow is adjustable between soothing and penetrating.

Euro Jets: Small-nozzle jets providing a penetrating massage, designed to dissolve tension. This jet may also serve as the entry point for ozone during the automatic filtration cycles. Ozone production is disabled when other functions are activated on the control panel by the spa user.

Comfort Collar

In the Horizon Series spas, the water flow to the Comfort Collar Neck Jets can be controlled by turning the valve adjacent to the therapy seat.

Air Controls

The intensity of the jet action can be controlled by

altering the amount of air injected with water through the jets. Your spa has either 2 or 3 air controls (depending on the model) located on the lip of the spa. Each control activates air to specific jets in the spa allowing you to create various combinations and levels of jet action to suit individual taste.

Note: Air controls should be closed during heating cycles for maximum energy efficiency.

Air Injectors

The air injectors generate a vigorous air and water massage action throughout the spa.

Note: At the beginning of the second filtration cycle, the air injectors are activated for thirty seconds to clear the air injectors and ensure complete filtration.

Maintenance

Water Chemistry

Water chemistry is critical in a spa system. The combination of high temperature and small volume means that the chemical balance must be watched carefully. Use only genuine Coleman Spas' spa care products for the best performance and to keep your water properly balanced for years of enjoyment. It is recommended that you purchase a Coleman Spas Spa Care Start Up Kit from your dealer. For water usage information, please see the table on page 20

Sanitizing

Sanitizing your water destroys harmful organisms and keeps your spa healthy and safe. Two commonly used spa sanitizers are bromine and chlorine, with ozone being used as an oxidizer. Chlorine and bromine are chemicals that you will add to the water. Ozone is a gas that is produced by an ozonator and injected into the water. It is important that a residual of sanitizer remain in your water. High water temperature, aeration and use will increase the need for sanitizer. In addition to maintaining a residual, it is important to "shock" your spa water periodically

Maintenance

and after heavy use. This addition of substantial amounts of sanitizer super-chlorinates the water and oxidizes non-filterable organic residue. Allow the sanitizer level to drop back to the residual amount before using. Also use your Clean Up Cycle, page 13 or 17, after heavy use for additional filtration.

Note: Coleman Spas does not recommend the use of trichlor (swimming pool chlorine) in its spas.

pH Level

pH is a balance of acidity and alkalinity in the water. Maintaining proper pH is important for the effectiveness of your sanitizer, for user comfort and to prevent corrosion of the spa equipment.

Note: Keep a chlorine or bromine residual of 3.0 to 5.0 ppm. Tests should be done daily with your test kit.

Note: Never mix two chemicals together. Never store any chemicals in the equipment compartment.

Note: Do not use muriatic acid to balance pH as it will damage your spa surface and equipment.

Recommended Levels

pH: 7.2–7.6 (Ideal 7.4–7.6)

Sanitizer Residual: 3.0–5.0 ppm

Total Dissolved Solids: 100–200 ppm

Free Available Sanitizer: 3.0–5.0 ppm

Note: Make sure you use fresh test kit reagents. They lose their accuracy with age. (Date the bottle upon purchase). Recommended to use tri-color vs. di-color test kit.

Total Alkalinity: 80–100 ppm ideal for dichlor, and bromine.

pH Sensor Operation

Horizon series spas equipped with the pH sensor option will provide an accurate pH reading to assist water maintenance. To view pH, touch the time pad twice. Recommended range is 7.2 to 7.6. If the pH of the spa water is outside of this range, the display will alternately flash the current temperature and pH reading. If this occurs, add chemicals as necessary to bring the pH into range.

Water Maintenance With the Powerworks® Ozonator

Equipping your spa with a Powerworks® Ozonator is a smart decision. The use of ozone in conjunction with the normal spa sanitizing and water balancing

chemicals will give you a cleaner, healthier spa environment. Maintenance and chemical usage may be significantly reduced, and you will enjoy cleaner water.

Sanitizing With Ozone

Spas vary in size and the amount that they are used will vary considerably from family to family. For this reason you will need to establish your sanitizing program based upon your own personal use. When using ozone you should start by balancing your water chemistry as you normally would. A spa should run and be ozonated no less than six hours per day. This starting point should not be considered final. If your spa is heavily used, this run time should be increased. Your spa produces ozone during filtration cycles. (See page 13 or 17.)

The amount of a residual sanitizer (chlorine or bromine) that you maintain in the water will also vary depending on use. It is recommended that you maintain a residual of 3.0–5.0 ppm. Periodically, and after periods of heavy use, it is necessary to “shock” your spa with additional amounts of sanitizer. Refer to your spa care products for further information.

Specialty Chemicals

Although ozone will reduce the need for specialty chemicals, it is recommended to always have some on hand. There may come a time when you will be required to add some of these due to heavy usage of the spa or when changing the water.

If you are in an area which has metals in the source water, a specialty chemical program should be followed to avoid staining. Use only genuine Coleman Spas’ spa care products for the best performance and to keep your water properly balanced for years of enjoyment.

These guidelines cover the most common procedures when operating a spa with ozone. Should you encounter a situation which you don’t completely understand, contact your dealer for assistance.

Hot Water Guide

Problem	Cause	Solution
Cloudy Water	<ul style="list-style-type: none"> • Inadequate filtration/dirty filter • Excessive oils/organic matter • Improper sanitation/bacteria • High pH and/or high alkalinity • Suspended particles/organic matter • High total dissolved solids (TDS) 	<ul style="list-style-type: none"> • Check to make sure the filter is running properly/Clean filter with a filter cleaner or degreaser. • Shock the spa with a chlorine or bromine sanitizer/shock or other shock treatment product. • Increase sanitizer level to balance water and shock if needed. • Adjust pH; add appropriate sodium bisulfate product. • Use clarifier Note: If using an ozone generator, do not use polymer based clarifiers. • Depending on the severity-drain the spa to half and refill; or drain the spa completely, clean and refill.
Water Odor	<ul style="list-style-type: none"> • Excessive organics/too many chloramines insufficient free available • Improper sanitation • Inadequate filtration • Low pH 	<ul style="list-style-type: none"> • Shock the spa with a chlorine or bromine sanitizer/shock or other shock treatment product. • Increase sanitizer level to balance water; shock if needed. • Check to make sure the filter is running properly/Clean filter with a filter cleaner or degreaser. • Raise pH with sodium bicarbonate product. If metals are present, add chelating agent.
Chlorine Odor	<ul style="list-style-type: none"> • Too many chloramines-insufficient free available chlorine • Low pH 	<ul style="list-style-type: none"> • Shock the spa with a chlorine sanitizer/shock or non-chlorine shock treatment. • Adjust pH; raise pH with sodium bicarbonate product.
Bromine Odor/ Yellow Water	<ul style="list-style-type: none"> • Low pH 	<ul style="list-style-type: none"> • Adjust pH; raise pH with sodium bicarbonate product.
Musty Odor	<ul style="list-style-type: none"> • Bacterial or algae growth 	<ul style="list-style-type: none"> • Shock the spa with a chlorine or bromine sanitizer/shock or equivalent shock treatment product. If problem is visible drain, clean, refill and balance spa.
Foaming/Scum Ring Around the Tub	<ul style="list-style-type: none"> • Build up of body oils, lotion and chemicals resulting from soap or detergent 	<ul style="list-style-type: none"> • Add defoamer; or drain and refill.
Algae	<ul style="list-style-type: none"> • pH Imbalance • Low free chlorine or bromine concentration 	<ul style="list-style-type: none"> • Adjust pH • Shock with a chlorine or bromine sanitizer/shock or other shock treatment product.
Eye Irritation	<ul style="list-style-type: none"> • Low pH • Insufficient free available chlorine 	<ul style="list-style-type: none"> • Raise pH with sodium bicarbonate product. • Shock with a chlorine sanitizer/shock or other shock treatment product.
Skin Irritation/ Rash	<ul style="list-style-type: none"> • Unsanitary/polluted water 	<ul style="list-style-type: none"> • Keep recommended sanitizer residual at all times; superchlorinate or use a non-

Maintenance

	<ul style="list-style-type: none"> • Soaking too long • Water temperature too high 	<ul style="list-style-type: none"> chlorine shock treatment. • Soak for smaller intervals, such as 15 minutes. • Reduce water temperature.
Scale	<ul style="list-style-type: none"> • Too much calcium dissolved in water pH and total alkalinity too high 	<ul style="list-style-type: none"> • Add a scale control product. Adjust total alkalinity and pH levels by adding the appropriate sodium bisulfate product; with concentrated scale deposits-drain the spa, scrub the scale off, refill the spa and balance the water.
Erratic pH Test Results/Unusual pH Test Color	<ul style="list-style-type: none"> • Sanitizer level too high • Old pH indicator dye 	<ul style="list-style-type: none"> • Test the pH, when the sanitizer level is below 5 ppm • Replace the pH indicator dye.
Sanitizer Dissipating Too Rapidly	<ul style="list-style-type: none"> • Excessive organics in water • Temperature too high • Low pH • Low pH Corrosion of Metal Fixtures • Low calcium hardness • Low total alkalinity 	<ul style="list-style-type: none"> • Increase shock dosage; add sanitizer; have bathers shower before entering spa. • Reduce temperature. • Raise pH with sodium bicarbonate product. • Use a chelating agent if metals are present. Keep proper pH level (7.2 to 7.6). • Use a chelating agent if metals are present. Maintain minimum 150-200 ppm calcium hardness. • Use a chelating agent if metals are present. Maintain proper alkalinity for type of sanitizer used.

BioQuest

Your spa may be accessorized with one of Bioquest's bromine generating systems. These sanitizing systems generate bacteria killing bromine gas from salt compounds added to your spa's water. They also reduce the amount of chemicals that need to be periodically added to your spa. Please refer to your BioQuest Operator's Manual for further details.

Use only genuine Coleman Spas' Spa Care products for the best performance and to keep your water properly balanced for years of enjoyment.

Spa Cabinet Care

Your custom spa cabinet is made from quality handcrafted redwood or cedar. It has been treated with a sealer and stain prior to spa assembly to preserve its appearance and help prevent weathering. Further wood protection requirements depend on spa location (indoors or outdoors, sun, shade, etc.), and local climate conditions. **Re-treat 3 to 4 times per year, with an appropriate product recommended by your authorized dealer.**

Cleaning the spa cabinet: Rinse dirt and dust regularly with clear water. To remove stubborn dirt,

grime, and mild discoloration, wash with a mild detergent and warm water.

Spa Surface Care and Cleaning

Your spa shell is made of a reinforced acrylic material. A minimum amount of care and cleaning will keep your spa looking new for years.

To protect your spa finish, always keep your cover on the spa when not in use.

Use a spa cleaner for residue and lime buildup at the water level of the spa surface. This can be applied to the acrylic surface with a soft cloth and wiped clean. Use small amounts to avoid polluting spa water. It may be necessary to lower the water level 2 to 3 inches before cleaning if heavily soiled at the waterline.

Use common household, non-abrasive cleaners to clean your spa shell. (For example: Lysol Basin, Tub & Tile Cleaner®; Glass Plus®; Mr. Clean®; and Top Job®, or a mild dishwashing detergent such as Ivory® Liquid.) Rinse well and dry with a clean cloth.

Never use abrasive cleaners.

Do not allow your spa's acrylic surface to come into contact with products such as acetone (nail polish remover), nail polish, dry cleaning solution, lacquer thinners, gasoline, pine oil, etc.

Remove dust and dry dirt with a soft, damp cloth.

Clean grease, oil, paint and ink stains with isopropyl (rubbing) alcohol.

Avoid using razor blades or other sharp instruments that might scratch the surface.

Filter Maintenance

The removable filter cartridge is located in the filter canister beneath the strainer basket. The filter should be inspected at least **monthly during normal use**, and more often during heavy use.

Keep the filter clean! A clogged filter decreases both performance and water quality.

To clean the filter, simply follow these steps:

(Note: It is not necessary to drain the spa.)

1. Turn the pump off.
2. Remove skimmer lid.
3. Remove strainer basket.
4. Remove filter cartridge from the filter canister by grasping the top and lifting upwards.
5. Soak, filter in filter cleaner/degreaser and hose out filter cartridge, unless replacing with new cartridge.
6. Place filter cartridge back into filter canister. When the spa is empty the Weir door will block the filter canister. You must hold it out of the way when reinstalling the cartridge. When the tub is full of water the door will float so you will have easy access for installing the filter cartridge.
7. Replace strainer basket and skimmer lid.
8. Turn the pump ON.

Note: During normal filter maintenance, it will be necessary to occasionally remove oils that coat the filter reducing filter flow. To remove these oils, soak the cartridge in a plastic pail containing a commercial filter cleaning solution (available from your Coleman Spas dealer or most pool supply stores). Follow the manufacturer's instructions for use.

We suggest that you replace your filter cartridge yearly to maintain optimum performance. Filter

maintenance depends on usage. Coleman recommends the filter be cleaned once every 90 days at a minimum, more often after heavy use or if water becomes cloudy.

Draining Spa

Always turn power off to your spa before draining. Immediately after turning the spa back on, lower the temperature setting so the heater will not come on. Keep the heater disabled until you have full flow coming out your jets for several minutes.

The water level in the spa must be kept at its normal level water line mark. **Note:** Evaporation and splashing will cause the water level to drop.

High concentrations of impurities caused by water evaporation, body oils, perfumes, and other contaminants may accumulate in the spa and cannot be filtered out. Consequently, it is advisable to drain your spa and refill it with fresh water every six to eight weeks or more often, depending on the amount of use. **Note:** Spas equipped with BioQuest automatic sanitizing systems may require less frequent draining. Refer to your owner's manual.

Drain Access

Drain access is in the black pedestal base adjacent to the equipment service panel. Simply remove the screws holding the access panel on and pull the drain hoses out.

Then attach a garden hose to the spa drain faucets and open the valves. Do not attempt to use the pump to drain the spa.

Priming Spa

Be aware that after draining and refilling your spa you may need to discharge air in the system in order for the pump to operate again. Should you experience an air-lock, you can remove the filter and insert a garden hose into the center hole and flush water through the system.

Maintenance

Warning: Turn off electrical supply before removing cabinet panels.

Winterizing

In cold climates where freezing temperatures occur, special care is required to prevent the possibility of damage to the spa and equipment due to freezing.

If you plan on using your spa during cold months, be sure your pump and heater are in good working order. The spa shell has been insulated to provide efficient operation in cold weather areas.

Special Note: If you do not intend to use your spa during the winter months and there is danger of freezing, the spa must be winterized! You must do the following:

1. Turn off all electrical power to the spa.
2. Drain spa of all water. Use a wet/dry vacuum to remove water from the air injector lines.
3. Be sure to drain **all** drain hoses.
4. The filter should be drained, and the cartridge removed and cleaned.
5. Check to see that there is no water in the heater element chamber and air injector lines. (Loosen unions, pump unions, and drain plug on pump.)
6. If you cannot draw off all of the water (especially from hoses) R.V. antifreeze should be added to the remaining water through the bottom of the skimmer. Make sure antifreeze reaches the air injector lines by pouring it down several of the jets or air injector openings. If antifreeze is used, it must be an inhibitor Propylene Glycol such as Dow Frost available through Dow Chemical Distributors.
7. Clean your spa as per previous maintenance instructions.
8. Cover your spa with a waterproof, water-shedding, impenetrable cover, such as a tarp.
9. For further information on blowing out the plumbing lines and winterizing procedures, contact your local dealer.
10. If your spa is equipped with the pH sensor option, this sensor must be kept wet at all times. During winterization, remove sensor and reinstall original cap on sensor. The cap should

be filled with water.

Note: If you elect not to drain your spa and the temperature is going to be below freezing for extended periods of time, especially 0° F (-19.4°C) and sub zero, it is best to operate the spa heater at high temperature (95°–104°F) (35°–40°C). If the tub is not going to be used and kept in the 100°F (37.7°C) range, you may have problems if your power goes out. It is wise during these bad weather periods to set the thermostat higher. This will keep the spa water from freezing quickly if you have a power failure.

Light Bulbs

The Spa light bulb is serviceable from outside the spa. You must remove the redwood panel and insulation closest to the light. Once the panel is removed, look for the bulb holding bracket and pull bracket towards you to change the bulb.

Perimeter light bulbs (Horizon 400 series only) are serviced by turning the lens cap in either direction 90°. Remove the bulb by pulling it straight out. Replace the bulb and reinsert the lens by placing it back in the track and turning 90°. The perimeter light replacement bulb is a #158 with a wedge base, .24 amp, 3.36 watt.

Problem Solving Guide

Problem	Usual Cause	Solution
1. System not operating.	A. House circuit breaker tripped or if OFF position.	A. Reset circuit breaker on home breaker panel.
2. Heater not functioning.	A. Heater mode not selected. B. No power to heater. C. Thermostat set lower than water temperature. D. Heater not operating.	A. Refer to temperature and heater control instructions on pages 11&16. B. Check house circuit breaker. C. Set to desired temperature. D. Contact dealer.
3. Water not clean.	A. Clogged or blocked floor suction or skimmer. B. Filter clogged (dirty). C. Poor water chemistry. D. Insufficient filtering time. E. Improper maintenance. F. High content of solids in water.	A. Clean floor suction/skimmer. B. Clean or replace. C. See “Chemical Treatment” section. D. Run filtration mode longer. Contact dealer. E. See maintenance section. F. Use clarifier or drain and refill spa.
4. Abnormal water usage.	A. Excessive evaporation and/or splashing.	A. Use spa cover.
5. Overheating.	A. High ambient temperature B. Direct sunlight, high outdoor temps	A. See page 8, Indoor Installation. B. Move spa into shade, wait for cooler weather
6. Low water flow from jets.	A. Operating in FILTER mode-low speed. B. Clogged or blocked suction or skimmer. C. Dirty filter. D. Jets in off position. E. Diverta-Jet in whirlpool.	A. Select hi-speed jets. B. Clean floor suction/skimmer. C. Clean or replace. D. Open adjustable jets. E. Check Diverta-Jet position.
7. No water flow from jets.	A. Pump not primed. B. House circuit breaker tripped, no power to system. C. Faulty pump or motor. D. Pump surges.	A. See priming section page 23. B. Reset circuit breaker at home panel. C. Contact dealer. D. Low water. Check level on Weir door.

Problem Solving Guide

Problem	Usual Cause	Solution
8. Noisy pump and motor.	A. Clogged floor suction or skimmer. B. Low water level. C. Damaged or worn motor bearings.	A. Clean floor suction/skimmer. B. Add water to water level on weir door. C. Contact dealer.
9. Water leakage from under spa.	A. Check unions and drain hoses.	A. Tighten unions or drain caps
10. No air flow from jets.	A. Air control not open. B. Jet nozzle missing.	A. Open control. B. Inspect jets.
11. Motor will not operate.	A. House circuit breaker tripped or in OFF position. B. Improper or defective wiring or electrical supply. C. Thermal Overload Protection switch tripped.	A. Reset circuit breaker B. Contact dealer. C. Auto reset after motor has cooled. Contact dealer if motor continues to cycle.
12. Air injector motor will not operate.	A. OFF mode selected. B. House circuit breaker tripped or in OFF position. C. Motor or control defective.	A. Check selection. B. Reset circuit breaker on circuit breaker panel. C. Contact dealer.
13. Black powder film around water line.	A. Wearing in of air injector motor brushes.	A. Will disappear after use.
14. The spa will not shut off	A. Spa trying to heat B. 400 Series overlapping filter cycles. C. Spa is in filter cycle D. Freeze Protection	A. Check set temperature in Standard mode B. Reset filter times. C. Normal. No need to change. D. Wait for spa to heat to normal temperature

Spa Soaking Guidelines

- Persons with heart disease, diabetes, high or low blood pressure or any serious illness, and pregnant women should not enter a spa without prior consultation with their doctor.
- People with skin, ear, genital or other body infections, open sores or wounds should not use the spa because of the possibility of spreading infection.
- Before entering, look at the water in your spa. If there is cloudiness or foaming, or if a strong chlorine smell is present, the water needs treatment. Soaking in such water greatly increases your chances of getting a skin rash (pseudomonas). Be sure to maintain the water properly. Ask your Authorized Coleman Spas Dealer for guidance.
- Shower with soap and water before and after using the spa. Showering before use washes away many of the common skin bacteria, and removes lotions, deodorants, creams, etc. Perspiration and lotions will reduce the effectiveness of the sanitizer and lessen the ability of the filter to work efficiently.
- Enter the spa slowly and cautiously. Be careful of your footing, and allow your body to gradually get used to the water temperature. Leave slowly as well, because your leg muscles may be sufficiently relaxed to make you a bit unsteady, and you may become lightheaded.
- Soaking for too long makes some people nauseous, dizzy, lightheaded or faint. **Don't soak in 104°F (40°C) water for an extended period of time.** If you wish to soak for a longer period of time in high temperatures, leave the spa after 15 minutes, shower, cool down and then return for another brief stay. In lower temperatures (e.g. 98.6°F (37°C)—normal body temperature) most people can comfortably and safely soak for longer periods at one sitting. If you have any questions about what's right for you and your family, consult with your doctor.
- Be sure you check the water temperature before and while in the spa.
- Never use the spa while under the influence of alcohol.
- With any drug or medication, consult with your doctor about potential harmful effects from combined use of the drug and hot water soaking.
- Never use the spa when you are alone, for safety's sake.
- Never allow children to use the spa unsupervised.

Technical Specifications

Structural Features	Model 408	Model 411	Model 447	Model 448	Model 450	Model 455
All heart, premium, redwood cabinet	Horizontal & Vertical	Horizontal & Vertical	Horizontal & Vertical	Horizontal & Vertical	Horizontal & Vertical	Horizontal & Vertical
Dimensions (allow 1/4" variance)	90 ⁵ / ₈ " x 74 ³ / ₄ " x 29 ⁷ / ₈ "	90 ³ / ₈ " x 90 ³ / ₈ " x 34 ⁵ / ₈ "	89 ³ / ₈ " x 77 ¹ / ₂ " x 34 ⁵ / ₈ "	88 ⁷ / ₈ " x 90 ³ / ₄ " x 34 ³ / ₄ "	89 ³ / ₈ " x 89 ¹ / ₂ " x 34 ⁵ / ₈ "	90 ¹ / ₈ " x 89 ¹ / ₂ " x 34 ⁵ / ₈ "
Seating Capacity	4	6	5	7	6	5
Usable Gallons	232	344	320	383	335	335
Weight in lbs(empty/full)	605/2534	781/3650	650/3423	758/4933	677/3467	677/3467
Electrical Requirements	240V, 30A/50A	240V, 30A/50A	240V, 30A/50A	240V, 30A/50A	240V, 30A/50A	240V, 30A/50A
Structural Features	Model 208	Model 250	Model 255	Model 260		
Western red select cedar cabinet	Diagonal	Diagonal	Diagonal	Diagonal		
Dimensions (allow 1/4" variance)	90 ⁵ / ₈ " x 74 ³ / ₄ " x 29 ⁷ / ₈ "	90 ³ / ₈ " x 89 ¹ / ₂ " x 34 ⁵ / ₈ "	90 ¹ / ₈ " x 89 ¹ / ₂ " x 34 ⁵ / ₈ "	79 ¹ / ₂ " x 89 ¹ / ₂ " x 34 ³ / ₄ "		
Seating Capacity	4	6	5	5		
Usable Gallons	232	331	335	337		
Weight in lbs(empty/full)	605/2534	643/3404	677/3467	583/4154		
Electrical Requirements	240V, 30A/50A	240V, 30A/50A	240V, 30A/50A	240V, 30A/50A		

Horizon 400 System Wiring Diagram

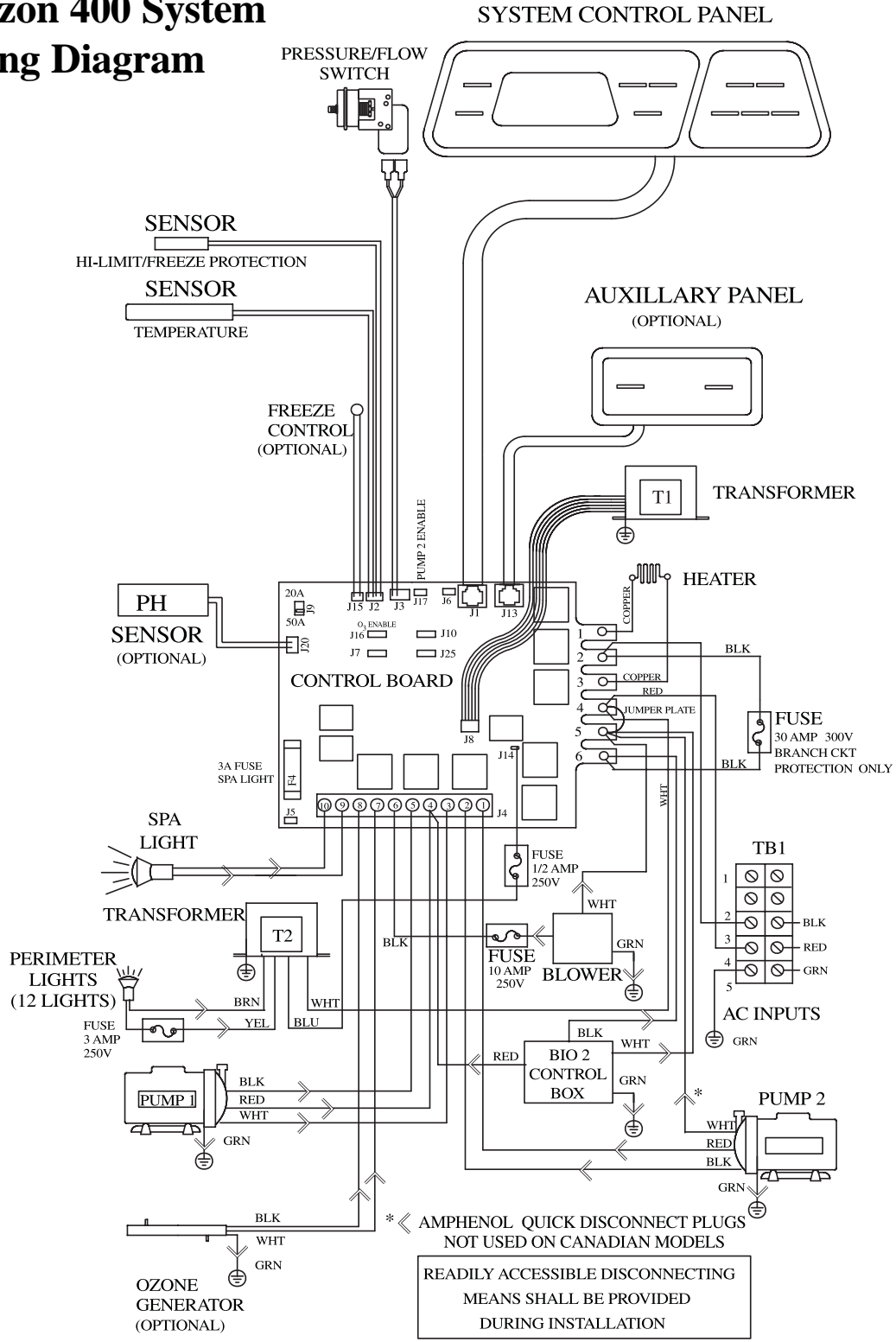

Spectrum 200 System Wiring Diagram

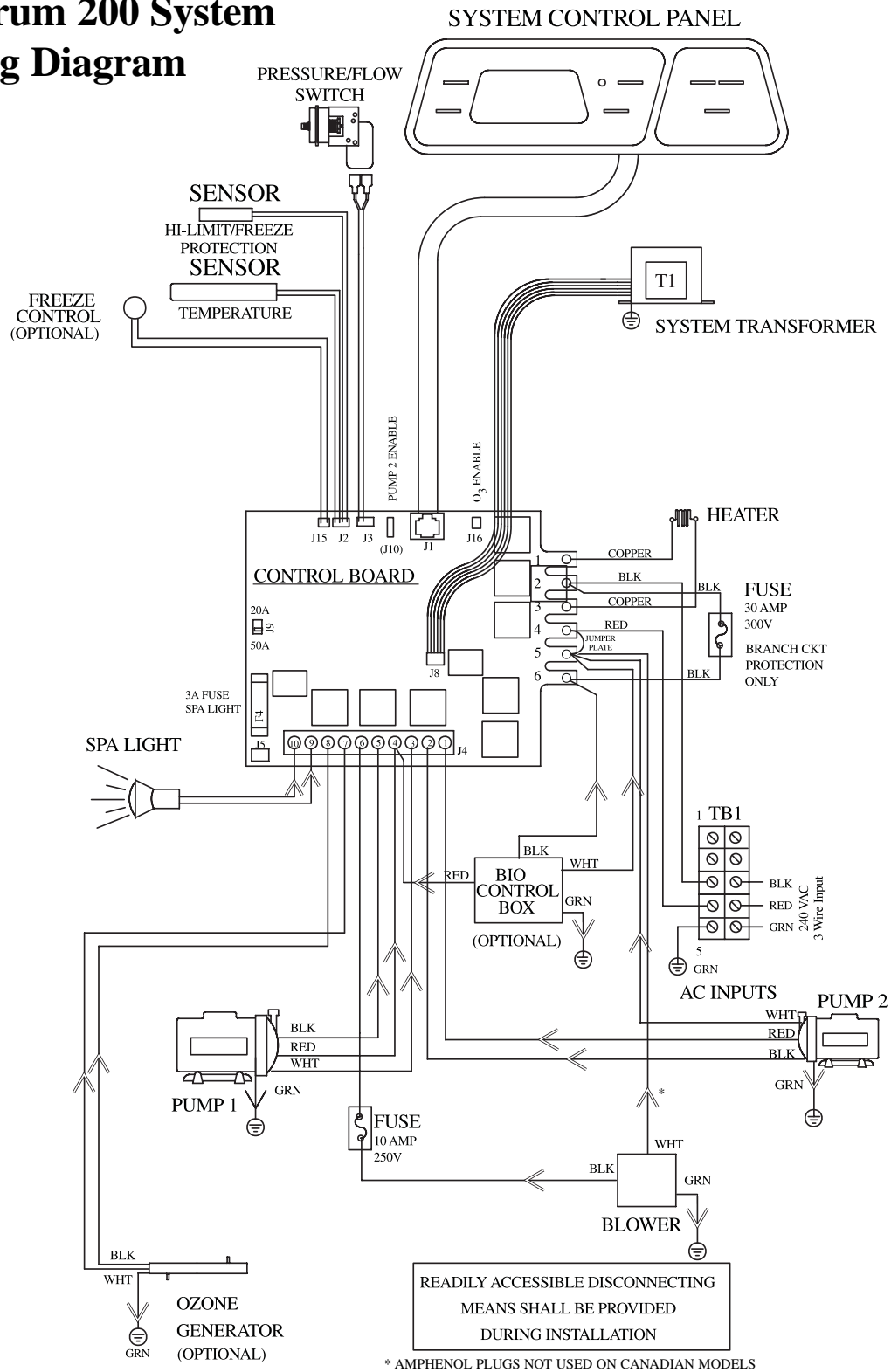

Safety Sign

The safety sign enclosed with your Owner's Manual should be permanently installed where visible to the users of the spa.

The sign is adhesive backed and there are also four screws supplied for mounting on rough surfaces.

It is very important that you, as a spa owner, review the important safety instructions before you operate your spa. It is equally important that you instruct all users, even occasional ones, as to the warnings associated with spa use.

You may obtain additional signs or replacement ones by contacting:

COLEMAN SPAS, INC.
Customer Service
25605 South Arizona Avenue
Chandler, Arizona 85248

COLEMAN SPAS SPA CARE ACCESSORIES

<u>ITEM/DESCRIPTION</u>	<u>PART NUMBER</u>
Powerworks Ozone System (Series IV) 240V - Horizon, Spectrum	4401-2355
pH Sensor Kit (Horizon only)	4401-2473
Nature2 Purifier	8000-0001
Scum Out (1 pt)	8000-0003
Stain & Scale (1 pt)	8000-0004
Spray & Rinse (1 pt)	8000-0005
Filter Klean (1 lb)	8000-0006
Gardenia Scent (.5 pt)	8000-0007
Jasmine Scent (.5 pt)	8000-0008
Gardenia Pillow	8000-0009
Jasmine Pillow	8000-0010
Liquid pH Up (1 pt)	8000-0011
Liquid pH Down (1 pt)	8000-0012
Go-Brom (1 lb)	8000-0013
Bromine Tabs (1.75 lb)	8000-0014
Bromine Floater (6 oz)	8000-0015
Shock Out (1.25 lb)	8000-0016
Quick Dip Test Strips (Bromine)	8000-0017
Quick Dip Test Strips (Bromine) blister pkg	8000-0020
Metal Protector (1 pt)	8000-0035
Alkalinity Up (1.25 lb)	8000-0036
Quick Dip Test Strips (Chlorine) blister pkg	8000-0018
Quick Dip Test Strips (Chlorine)	8000-0019
Defoamer (pt)	8000-0021
Chlorine (1 lb)	8000-0022
Chlorine (2 lb)	8000-0023
Starter Kit	8000-0024
BioQuest Starter Kit (1)	8000-0049
BioQuest Starter Kit (4)	8000-0029
Rubber Ducks	8000-0025
Cover Valet #HS-400	8000-0082*
Cover Valet CC/SM 250	8000-0086*
SpaSense System (240V)	4401-2471

*Depends on spa model-Consult your retailer.

Horizon & Spectrum Series



Owner's Manual

**CHOOSE A MANUAL
TO VIEW**



Owner's Manual

Journey™
1999



Owner's Manual